

FUJI Elevator
www.fujielevator.com.cn



FUJI

Warning

This publication is for general informational purposes and we reserve the right at any time to alter product design and specification. No statement contains should be construed as a warranty or condition, express or implied, as to any product, its fitness for any particular purpose or quality, or any modifications or representation of the terms of any purchase agreement.

富士エレベーター会社
FUJI Elevator Company

FUJI

FUJI High Technology
Smooth start, Quick and quiet Moving

FUJI Control System

FUJI Elevator, Advanced Technology, Smooth Start, Quiet Moving

FUJI VVVF drive ensures FUJI Elevator operate more smoothly. Nice noise control brings passenger peaceful riding experience. The start, acceleration, brake curves are designed according to the ergonomic theory in order to get the finest coziness. It is a genuine current vector control variable frequency drive system. The permanent magnetic synchronous drive saves up to 46% in energy consumption. The professional intelligent group control management system can control 8 elevators. The advanced artificial intelligent and traffic flow database technology increases greatly the traffic efficiency thus minimizes the waiting time.

Permanent Magnet Synchronous Gearless Traction Machine

We choose rare earth material and fully combine coaxial transmission technology and digital variable frequency technology with group computer combined control technology. With less running cost & less energy dissipated. Compared with the ordinary and traditional technology, gearless traction machine can save more than 46% of the energy. Gearless traction machine needs no renewal of lubricant. Without grease pollution, low noise, quiet & natural.

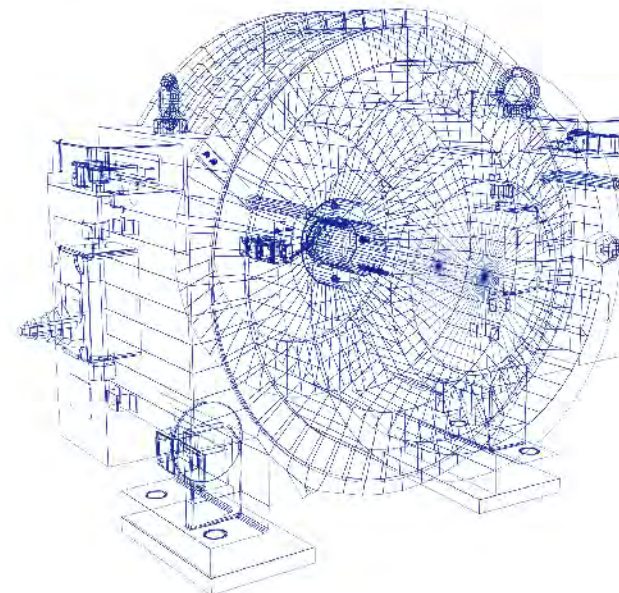

High Precision Positioning Control System

Car displacement tracking technology ensures the leveling safety. Car-displacement-detection technology with high accuracy makes almost perfect leveling between the car and the landing level.

Panasonic Top Advanced Door Operator System

FUJI Elevator applies the advanced Panasonic VVVF variable voltage and variable frequency control technology to the elevator door operator system so as to ensure the smooth elevator door and quiet switch. What is more, the self-learning door load detector increases the sensitivity of the elevator door switching on/off. It monitors the variation of elevator door load on every floor. Automatically rectifying the most appropriate open / shut speed in every floor so as to guarantee the security and reliability.

FUJI Elevator

HENGFU GROUP INDUSTRIAL INTELLIGENT OF 4.0 FACTORY SET SAIL

FUJI Elevator
富士エレベーター

FUJI Elevator Company is approved by the state administration for industry and commerce of the national professional elevator manufacturing enterprises, is the national special equipment manufacturing and installation maintenance license double-a qualification holding enterprise. Registered capital of 300 million yuan, the company was founded in 1987, in nearly 30 years development course, FUJI has been into a period of innovation and development, is the present domestic domestic machine elevator brand in the scale of production, the annual sales, one of the largest enterprises in market share, etc.

Industrial intelligent 4.0 new factory has set sail with glory! As the largest and the most advanced machine equipment modern large manufacturing base in ZheJiang province, the company independent research and development and innovation as the source of enterprise rapid development and motivation. Set up the product research and development center, focus on new product development, technical innovation, we uphold: "dedicated to provide our customers with satisfactory products, first-class service", The quality of the products are strictly controlled from design to manufacturing, from installation to services. To provide customers with cost-effective elevator products, also reflects our deep concern and commitment of social responsibility that we take!

Company is based on scientific and technological innovation, in the innovation of science and technology company has won the "two-way dynamic solar photovoltaic elevator" approved by the state patent office for more than one hundred invention patents and utility model patents, at the same time the company has more than a dozen is under examination and approval of invention patent has been accepted.

FUJI Elevator will hold the idea of "cherish, integrity, innovation, gratitude", to achieve a win-win development with preferential prices and nanny service. Our joint efforts will make thousands of families enjoy more security, environmental protection, comfortable elevators the FUJI Elevator provides.

Four stages of the project total investment nearly 1 billion RMB, covers an area of nearly two hundred mu, total construction area of 80000 square meters, has a new type of vertical elevators, escalators, moving walks, 6 sets of the world's advanced fully automated production line and r&d center, intelligent office building contains 10 meters per second, 150 meters high elevator testing tower. Intelligent layout in accordance with the standards of world class factory, take lead in introducing industrial 4.0 concept, make the production capacity improved, the annual output of 50000 sets elevator machine, 5000 sets of parking equipment and 20000 sets of elevator accessories production capacity



International Top Equipments



Introducing International top equipments and make "made in china" affect the world

As the largest and the most advanced machine equipment of the modern large manufacturing base in ZheJiang Province, company introduced SALVANINI and a series of the world's leading fully automated production lines, will be fully implemented 4.0 intelligent manufacturing industry, also reveals the enterprise in the field of "machine substitution" solid results.



- 1 CNC Center
- 2 Optical fiber laser cutting machine production line
- 3 Italy imported SALVANINI flexible sheet metal processing production line
- 4 KUKA robot in Germany

- 5 Spraying line (German WAGNER spraying room)
- 6 Escalator production workshop
- 7 Elevator production workshop
- 8 Company Exhibition Center
- 9 Office building



Achieve the annual output of 50000 sets of elevator machine, 5000 sets of parking equipment and 20000 sets of elevator accessories production capacity.

FUJI Factory Profile

With the three decades effort, FUJI Elevator embarks on a fresh chapter.

The industrial intelligent 4.0 plant has total USD130 million investment, includes 80,000 square meters of workshop and 18,000 square meters of office, equipped with the advanced Germanic and Italian full-automatic metal plate production equipments.



80,000m²
of workshop

18,000m²
of office



Cabin Production Line



Doors Production Line



130million
Total investment of USD

FUJI Factory Profile

The 4th plant is activated, this plant have total investment of USD130 million, which including 80,000 square meters of workshop and 18,000 square meters of office



Delivery Area



Escalator / Moving walks
Production Line

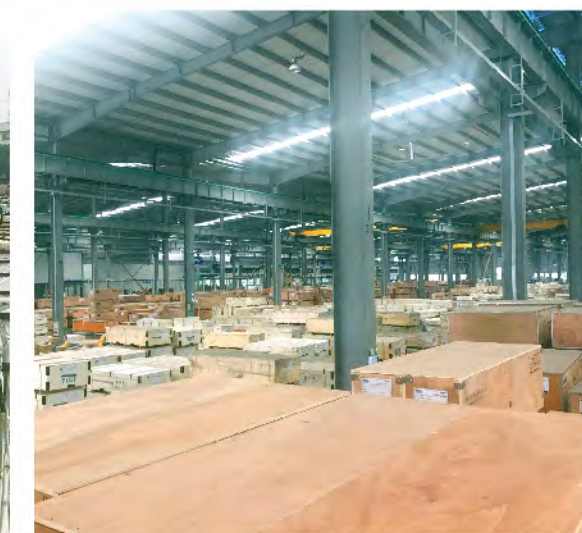

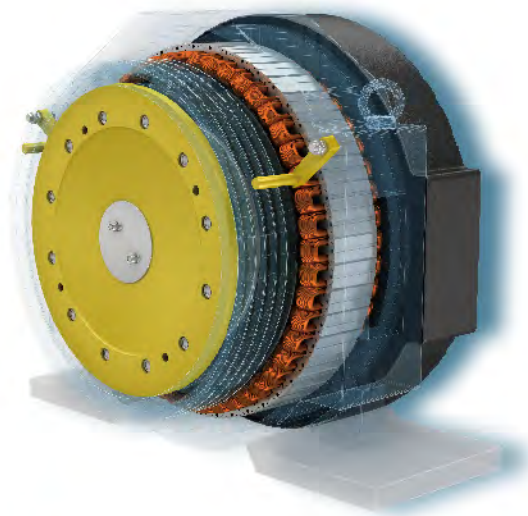

FUJI Factory Profile



FUJI Motors

Permanent Magnet Synchronous
Gearless Traction Machine
FUJI Intellectual Control System.



Electric Assembly Workshop

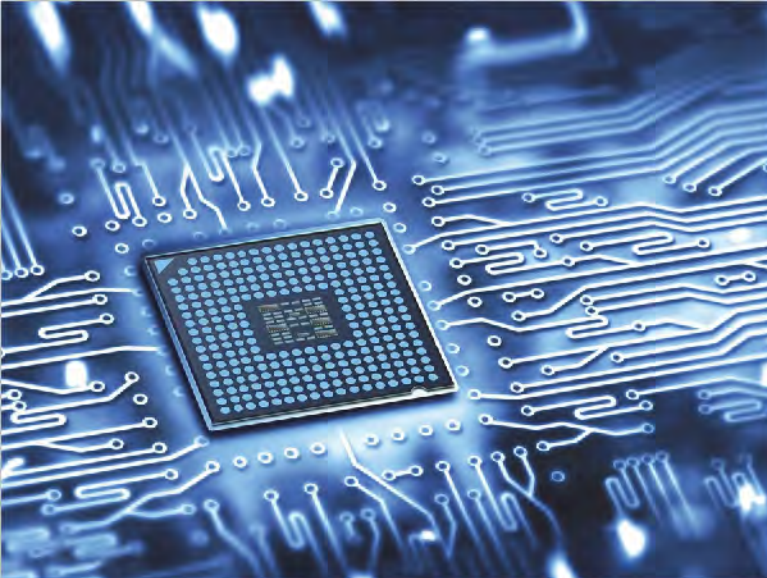

FUJI Intelligence System

FUJI Intellectual Control System

FUJI intellectual control system accurately measure the location of car during the operation of elevator; The real time calculation of the system can make sure the best running time always. While the elevator acceleration, deceleration and braking, it will be more steady, the running time for each floor will be less, the leveling accuracy improved, and bring superior riding comfort.

Best Running Cozy

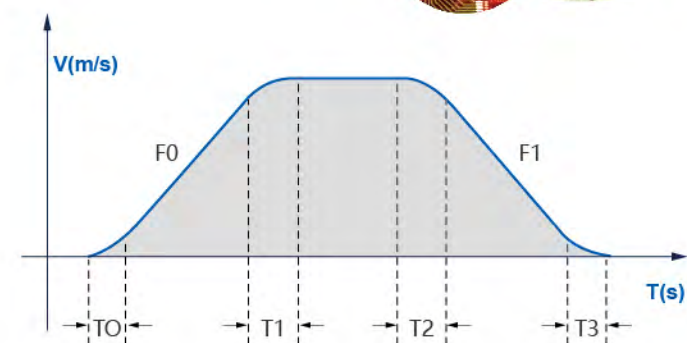
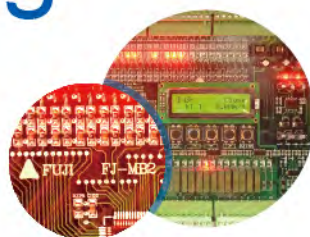

FUJI Digital Inverter Technology

Advanced vector conversion technology, according to human body riding comfort, it will take real-time speed adjustment. Advanced high-speed digital signal processing system can increase the sensitivity of the speed control of the traction machine, which will minimize the elevator vibration. The newest low-noise control technology can make the elevator operates quietly and steadily.



FUJI Permanent Magnet Synchronous Gearless Traction Machine

With the strong capabilities in designing, developing and manufacturing, FUJI aims at the diversified needs of clients and the various regional lift markets to develop the products in accordance with the diverse criterions. such as Asia Series, Europe Series, and North America Series, etc. Combining target market's feature, FUJI continuously introduces, develops and investigates, to ensure industry-leading technologies and products all the time.



Panasonic Door Operator System

Panasonic variable frequency door machine can freely adjust door opening/closing speed. It is equipped with self-study function. It internally sets the optimized running curve with the convenient adjustment. It owns the excellent closed loop control, instant control to the running speed and position, traditional travel switch software.

Door System with Multiple Protection Functions

- Door detection sensor
- Detection sensor in car door range
- Light curtain door sensor with shut prompt signal
- Line detector

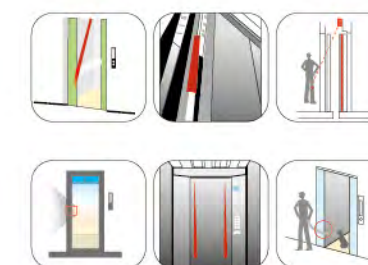

Industry-Leading Technologies

FUJI Intelligence System

Integral control system represents the developing orientation of the elevator control system. It is new generation intellectual vector type integral control system. It covers distance control, direct parking, closed-loop vector control technology, CANBUS communication technology, multi-CPU running technology and applies C and assembly language programming. It perfectly combines the contemporary industrial control technology, communication technology and traditional elevator. Compared with the traditional elevator control, it brings about the higher cost performance and the more convenient maintenance.

Group Control Managing System

Group control managing system is that multi same model elevator groups are controlled in use, the elevator groups can automatically choose the most appropriate response. It avoids the repeated elevator parking, reduces the passengers' waiting time and improving the travel efficiency.

Photocell Protection

FUJI elevator utilizes the sensitive and concentrative infrared ray photocell to form optical curtain protection safety net at the entrance of the elevator. It sensitively reacts to any person or object that enters into the probe plane freely entering in & out with high security.

Automatic Lighting of LED Energy-saving Lamp

We use energy-saving LED lamp. When nobody uses the elevator, the lighting in the car will turn off automatically & automatically turn on once receiving any calling commands. Saving the electricity energy consumption sufficiently.

Electromagnetic Compatibility Without Interference with Each Other

FUJI passenger elevator control system fully abides by the relevant electro-magnetic compatibility standard, removes the electro-magnetic pollution, effectively prevents from the electromagnetic wave interference between the elevator signals and various precision electrical equipments in the building.

Voice System

Under normal running arrival, report the floor that is about to arrive by utilizing the voice device, before elevator door closing, voice device will forecast next running floor, making the movement harmonious and natural.

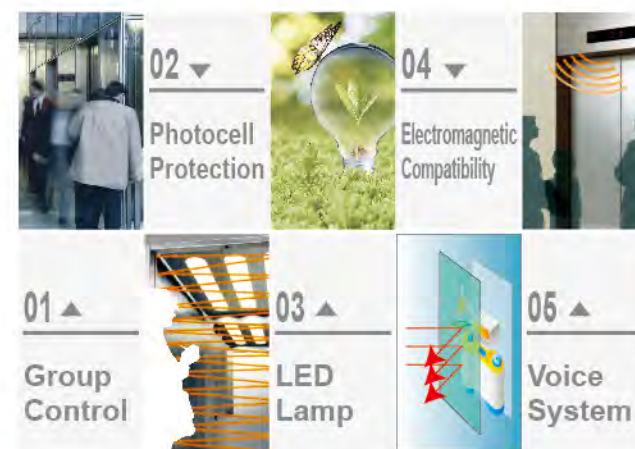
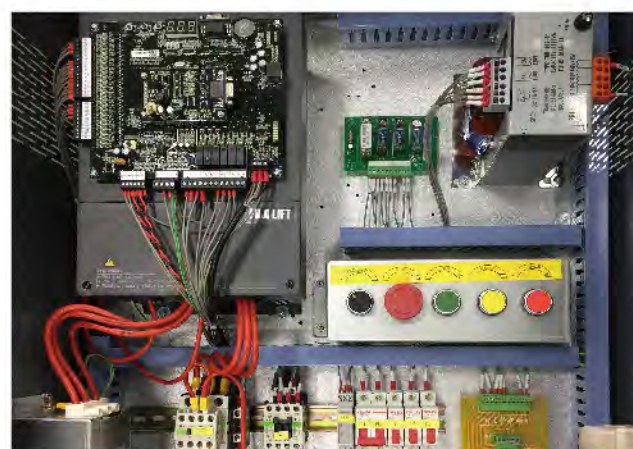

1 Permanent Magnet Synchronous Gearless Traction Machine

We choose rare earth material and fully combine coaxial transmission technology and digital variable frequency technology with group computer combined control technology. With less running cost & less energy dissipated. Compared with the ordinary and traditional technology, gearless traction machine can save more than 33% of the energy. Gearless traction machine needs no renewal of lubricant. Without grease pollution, low noise, quiet & natural.



2 Permanent Magnet Synchronous Gearless Traction Machine

Stay far away from city noise, enjoy a green space(Optional)

The peaceful running is below 50DB. It is obviously lower than the standard in the same industry. It greatly enhances the mute performance. It adopts no-vibration humane design, inner-rotor horizontal structure, high length-diameter ratio, the more reasonable structure, the more smooth operation, low braking noise, regulation-free clearance, low running temperature-rise, the longer service life, small bulk, light weight, space-saving, the more convenient installation.



Enjoy A Green Space

Small Machine Room Passenger Elevator

FUJI small machine room passenger elevator only has about 65%~70% of the traditional machine room. It greatly saves the building space and material. Control cabinet in machine room is designed into single-face inspection layout. The host bearing beam can also be used as hitch plate. It largely saves the machine room space. Compared with the traditional elevators, under the premise of ensuring the repairers' operation space which is stipulated by the national standard, it effectively controls the machine room height. The intensive space effect grants more freedom for the architects. It expands the larger space utilization to the construction, perfectly merges the well space with the architectural style.

Less Space, Faster Construction

Compared with FUJI small machine room elevator, machine room is only an extension of the elevator well. It brings about the more convenient installation, the lower cost as well.

Impressive Energy Savings

Compared with the traditional traction machine, FUJI small machine room elevator consumed less energy and brings about low loss in heat energy as well.

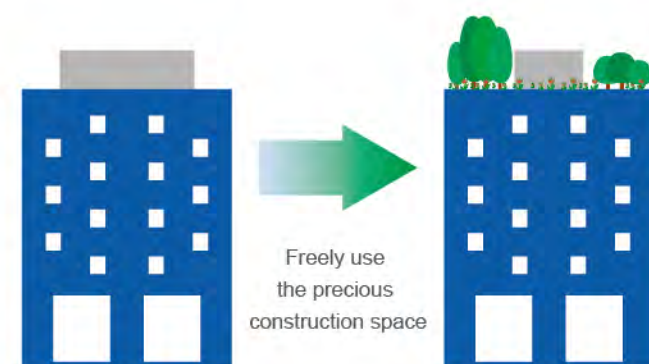

Machine Roomless Passenger Elevator

FUJI machine roomless passenger elevator cancels the machine room, reduces total area of the elevator equipment and flexibly utilizes the effective space. It has the stronger contemporary sense and the more beautiful construction outline.

The host and control device are designed at the shaft top to prevent from occasional water-inlet in the shaft which damages the drive device. In this way, it guarantees a highly reliable system.

Blended Into the Construction, Easily and Leisurely

FUJI machine roomless passenger elevator need only one independent hoist-way and do not need the presence of machine rooms. The architects and developers are allowed to conduct designing in a freer way.



We cancel the machine room to freely design the shaft position. We can flexibly and effectively apply the top space that is preset for machine room.



Project Achievements

Asia



Muscat International Airport, Oman



ITC PLAZA, Karachi, Pakistan



MONGORIA-IRIN Town, Mongolia

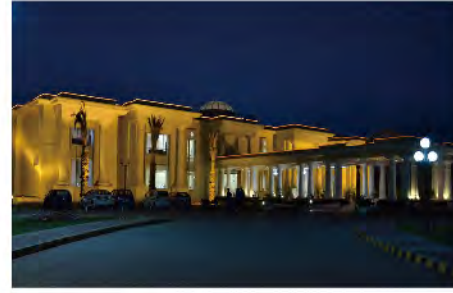

Barat Ghar Model Town, Pakistan



Pattaya Hotel, Thailand



Astro Complex, Saudi Arabia



Ayyar Chan Thar Executive Condominium, Myanmar



Azizya Mall, Riyadh, Saudi Arabia



BAGHDAD-PALESTINE STR, Iraq



ANB Centre Islamabad, Islamabad, Pakistan



Burj Huraia Fuji Escalators, Karachi, Pakistan



AL NAFOORA- UAE



Hyatt Regency Kinabalu, Baasha, Malaysia



Al-Mansor Mall, Baghdad, Iraq



Eastern Visayas Regional Medical Center, Philippines



Gloria Complex, Riyadh, Saudi Arabia

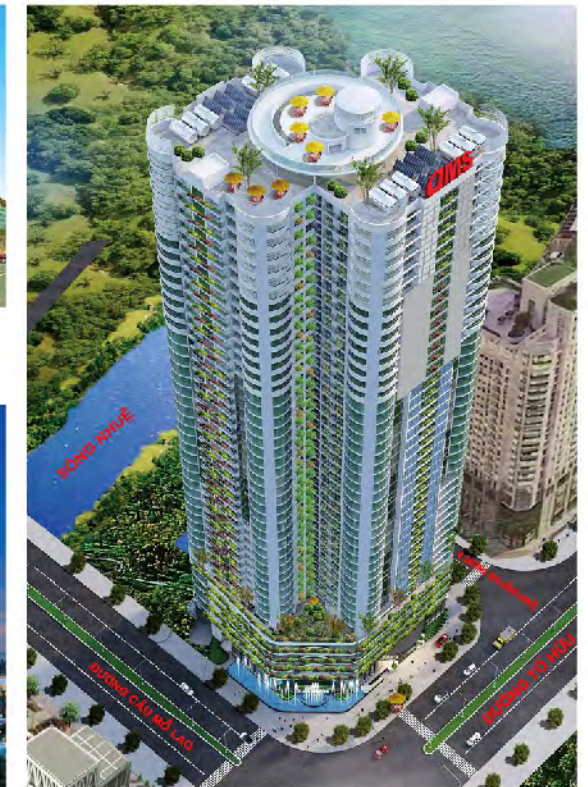

QMS TOWER- Hanoi, Vietnam



Pertamina building cilacap, Jakarta, Indonesia



HILTON Hotel, Philippines



Kayre Hotel, Lahore, Pakistan



Laos-Lake PhaThatLuang Shopping Plaza, Vientiane



Laos-PhaThatLuang Lake, Vientiane



MaHarMyatMuni,
MawlaMyaing, Myanmar



Mr.Faisal's Cousin,
Karachi, Pakistan



New Dawn Hotel Philippines



The Manor, Kuala Lumpur,
Malaysia



NEW CITY ARCADEWah, Islamabad, Pakistan



New City Tower, Laos, Vientiane

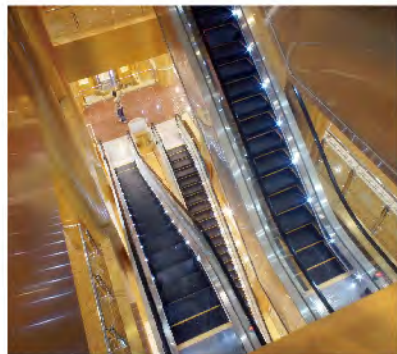

Noor Shopping Center, Iraq



Cerritos Holdings, Quezon City,
Philippines



Rajamangala University of Technology Krungthep,
Bangkok, Thailand



Republic of Lebanon



ROYAL HOME, Karachi,
Pakistan



SOUTH CITY, Karachi, Pakistan



The Bridge Cambodia, Cambodia

Africa



Altadamon-Altadamon
Bank, Africa



Bank of Sudan, Sudan



Sudan-Sudanese Pipe
Line Petroleum, Sudan



Mzizima Tower,
Tanzania



Sudan-Central Bank
of Sudan, Sudan



Blossom Plaza, Gudu Abuja,
Nigeria



GAMBIA-Talab Building,
Gambia



Nairobi University, Kenya



Panari Hotel Five Star Hotel,
Nairobi, Kenya



Presidential palace of South Sudan, Sudan



President's House, Juba, South Sudan



Sudan-Office Building, Sudan



Sudan-Sudanese
Agriculture Bank,Sudan



UGANDA-Ministry Of Industry
Building, Uganda

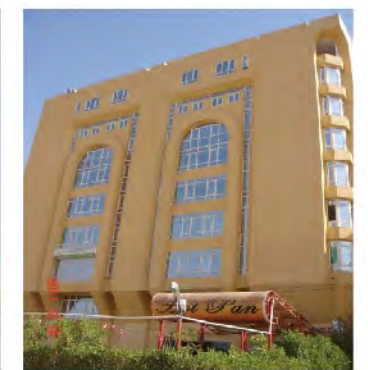

Sudan-Alsafa Plaza, Sudan

Europe



ALBANIA-The Bank of ALBANIA



Elia Shpy, Tirana, Albania



LCD Zolotoy-Russia



RUSSIA-Residential Quarters, Russia



SPAIN-Staff Dormitory, Spain



UKRAINE-Ukraine, Mykolaiv, Tynpct, Ukraine

America



Brazilian International Airport, Brazil



Centro Comercial Parque La Colina, Bogota, Colombia



Centro Commercial Fontanar, Bogota, Colombia



Oscar Freire Building, Sao Paulo, Brazil



Panama-colored De Bellavista, Panama city, Panama



Solhe, Bogota, Colombia



Wel Shpool, Australia



Manicore Suite Hotel, Columbia

China



Zhejiang Changxing Global Center



Ningbo Wahson International Home Plaza



Chongqing Museum of Natural History



Shandong Wujiangzhuang Resettlement Housing



Shanghai Minsheng Bank of China



People's Government of Gansu Yongjing County



Hangzhou Yunjing International



Aerial View of Lu'an Golden Sun



Shanghai Baogang Group



Jinzhai No.1 Middle School New Campus

Passenger Elevator



Standard Configuration

We apply one style of FUJI hairline stainless steel car with the distinctive ceiling to create the strong visual impact and bright & modern flavor.



Landing door and jamb: Hairline stainless steel is adopted for the first floor and plastic jet steel plate is adopted for other floors.



HD-DTA01

Diamond silver painted steel with acrylic photic board

HD-JX12 >>>

Ceiling

Diamond silver painted steel with acrylic photic board (HD-DTA01)

Operating panel

Integrated operating panel

Car wall

Hairline stainless steel

Flooring

Standard PVC (FJ-B01)
(optional marble)

Car door

Hairline stainless steel



Note: Pictures have been drawn by computer. It might be slightly different from actual colors. Please take real product as criterion.

Passenger Elevator

Optional Configuration



FJ-JX12-1A

- Car ceiling** Mirror stainless steel frame, lamp belt, LED lighting (HD-DTA14A)
- C.O.P** Embedded type
- Car wall** Hairline stainless steel, rear wall mirror stainless steel
- Floor** Standard PVC (optional marble)
- Car door** Hairline stainless steel



HD-JX12-1

- Car ceiling** Mirror stainless steel framework, acrylic arch paint-jet top plate in the middle and acrylic lighting decoration on both sides (HD-DTA05)
- Car wall** Stainless steel hairline on both sides, combination of stainless steel hairline and etched mirror at rear wall
- Floor** Standard PVC (optional marble)
- Car door** Hairline stainless steel



HD-JX12-2

- Car ceiling** Mirror stainless steel framework, acrylic arched top plate (HD-DTA02)
- Car wall** Stainless steel hairline on both sides, combination of stainless steel hairline and hairline mirror at rear wall
- Floor** Standard PVC (optional marble)
- Car door** Hairline stainless steel



HD-JX12-3

- Car ceiling** Mirror stainless steel framework, acrylic arched top plate, intermediate down lamp decoration (HD-DTA04)
- Car wall** Stainless steel hairline on both sides, combination of stainless steel hairline and etched mirror at rear wall
- Floor** Standard PVC (optional marble)
- Car door** Hairline stainless steel

Sweet prompt: Mirror car feels wonderfully. Please do not touch it and leave your fingerprints in mirror car. Thanks.

Sweet prompt: Mirror car feels wonderfully. Please do not touch it and leave your fingerprints in mirror car. Thanks.

Optional Configuration

Optional Matching



HD-JX12-4

- Car ceiling** Stainless steel mirror base-plate is supplemented by rectangle hollow transparent light pole. The soft lighting design of arched white light-passing board is in the middle part (HD-DTA03)
- Car wall** Stainless steel hairline on both sides, combination of stainless steel hairline and etched mirror at rear wall
- Floor** Standard PVC (optional marble)
- Car door** Hairline stainless steel

HD-JX12-6

- Car ceiling** Vortical square image main body board and tube lamp combining for soft illumination design (HD-DDB02)
- Car wall** Stainless steel hairline on both sides, combination of stainless steel hairline and etched mirror at rear wall
- Floor** Standard PVC (optional marble)
- Car door** Hairline stainless steel



HD-JX12-7

- Car ceiling** Stainless steel frame in middle, white transparent board on both sides of the soft lighting design, two sides made of stainless steel (HD-DT13)
- Car wall** Two sides made of stainless steel, the middle of the wall mirror etching stainless steel
- Floor** Standard PVC (optional marble)

HD-JX12A

- Car ceiling** Diamond silver painted steel with acrylic photic board (HD-DTA01)
- Car wall** Hairline stainless steel, back wall glass in the middle
- Handrail** Stainless steel flat handrail
- Floor** Standard PVC (optional marble)

Sweet prompt: Mirror car feels wonderfully. Please do not touch it and leave your fingerprints in mirror car. Thanks.

Sweet prompt: Mirror car feels wonderfully. Please do not touch it and leave your fingerprints in mirror car. Thanks.

Optional Matching



HD-JX03

- Car ceiling** Video vault in the middle, on both sides of the stainless steel floor with led light lighting design
- Car wall** Center plate, mirror stainless steel, on either side of the hairline stainless steel
- Handrail** Stainless steel round handrail
- Floor** Standard PVC (optional marble)



HD-JX04

- Car ceiling** Mirror frame, supplemented by led on mirror stainless steel plate, the middle section is arched white plate light lighting design
- Car wall** Center plate surface spray gold on mirror stainless steel, either side of the hairline stainless steel
- Handrail** Stainless steel flat handrail
- Floor** Standard PVC (optional marble)



HD-JX05

- Car ceiling** Stainless steel mirror base-plate is supplemented by rectangle hollow transparent ploe, the soft lighting design of arched white light-passing board is in the middle part
- Car wall** Center plate mirror etched stainless steel, two flanks hair grain stainless steel
- Floor** Standard PVC (optional marble)



HD-JX06

- Car ceiling** Mirror frame, supplemented by led on mirror stainless steel plate, the middle section is arched white plate light lighting design
- Car wall** Center plate mirror etched stainless steel, two flanks hair grain stainless steel
- Handrail** Stainless steel round handrail
- Floor** Standard PVC (optional marble)

Sweet prompt: Mirror car feels wonderfully. Please do not touch it and leave your fingerprints in mirror car. Thanks.

Sweet prompt: Mirror car feels wonderfully. Please do not touch it and leave your fingerprints in mirror car. Thanks.

Optional Matching



HD-JX61

- Car ceiling** Mirror stainless steel, acrylic lighting decoration, tube lamp
- Car wall** Combination of hairline stainless steel and etched mirror stainless steel
- Floor** Standard PVC (optional marble)



HD-JX62

- Car ceiling** Mirror stainless steel frame, acrylic transparent plate, LED lights
- Car wall** Mirror, etching, hairline
- Handrail** Stainless steel round handrail
- Floor** Standard PVC (optional marble)



HD-JX63

- Car ceiling** Stainless steel or metal stoving varnished frame, acrylic soft light illumination design
- Car wall** Hairline stainless steel, mirror etched stainless steel
- Floor** Standard PVC (optional marble)



HD-JX64

- Car ceiling** Mirror border, white transparent plate
- Car wall** Mirror, hairline, etching
- Floor** Standard PVC (optional marble)

Sweet prompt: Mirror car feels wonderfully. Please do not touch it and leave your fingerprints in mirror car. Thanks.

Sweet prompt: Mirror car feels wonderfully. Please do not touch it and leave your fingerprints in mirror car. Thanks.

Optional Matching



HD-JX65

- Car ceiling** Mirror border, white transparent plate, LED downlight
- Car wall** Mirror, vibration, etching
- Handrail** Stainless steel round handrail
- Floor** Standard PVC (optional marble)



HD-JX66

- Car ceiling** Mirror border, white transparent plate, LED downlight
- Car wall** Mirror, hairline, etching
- Handrail** Stainless steel round handrail
- Floor** Standard PVC (optional marble)

Sweet prompt: Mirror car feels wonderfully. Please do not touch it and leave your fingerprints in mirror car. Thanks.



HD-JX67

- Car ceiling** Mirror border, white transparent plate, LED downlight
- Car wall** Mirror, hairline, etching
- Handrail** Stainless steel round handrail
- Floor** Standard PVC (optional marble)

Sweet prompt: Mirror car feels wonderfully. Please do not touch it and leave your fingerprints in mirror car. Thanks.

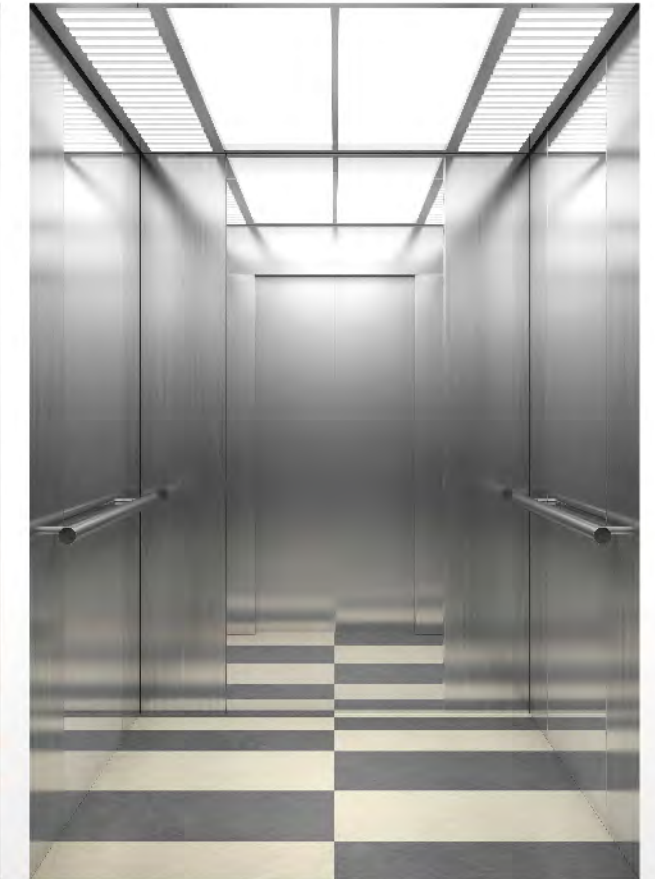

HD-JX68

- Car ceiling** Mirror border, organic paint board, organic strip
- Car wall** Mirror, hairline
- Floor** Standard PVC (optional marble)

Luxury Classic-Manner



FJ-JXA01 (Optional)

- Car ceiling:** Titanium gold mirror frame, LED, etched titanium gold mirror, ceiling lamp
- Car wall:** Marble, etched mirror, titanium gold mirror
- Handrail:** Titanium-plated stainless steel round tube, wood round tube
- Floor:** Standard PVC (optional marble)



Note: Pictures have been drawn by computer. It might be slightly different from actual colors.
Please take real product as criterion.

Luxury
Classic-Manner

Luxury Classic-Manner

FUJI Elevator
富士エレベーター



FJ-JXA02 (Optional)

- Car ceiling:** Titanium gold stainless steel
- Car wall:** Etched stainless steel mirror plated with bronze color, glass mirror
- Handrail:** Stainless steel round tube, wood handrail
- Floor:** Standard PVC (optional marble)

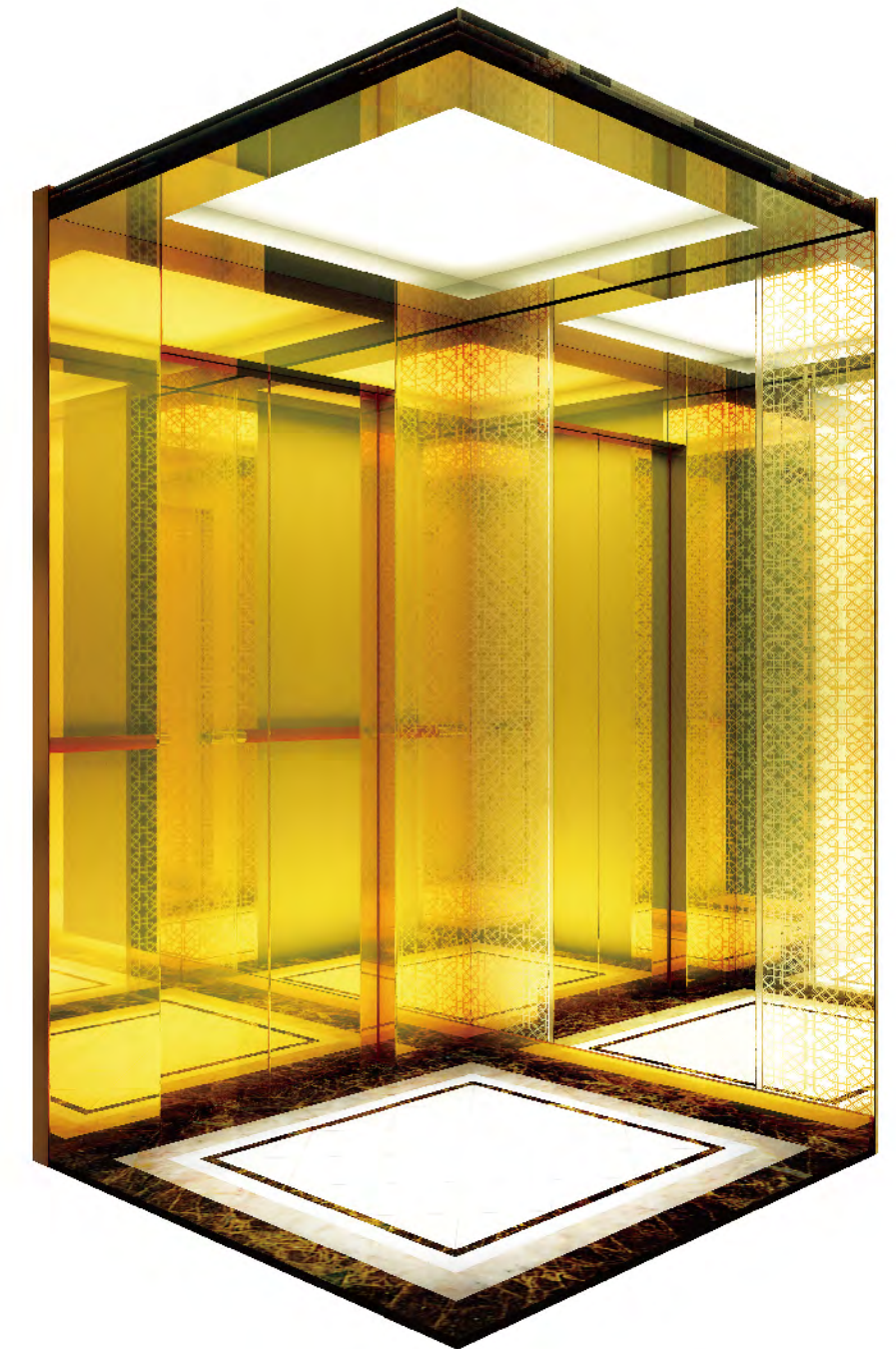

Note: Pictures have been drawn by computer. It might be slightly different from actual colors.
Please take real product as criterion.

Luxury
Classic-Manner

Luxury Classic-Manner

Minimalist Fashion-Model

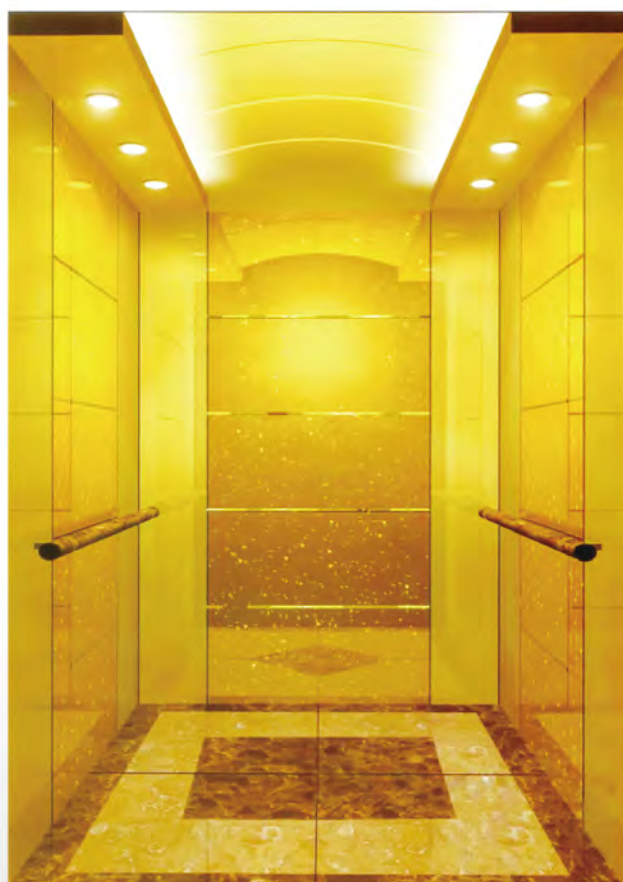

FJ-JXA03 (Optional)

- Car ceiling:** Titanium gold stainless steel arched ceiling
- Car wall:** Combination of glass and titanium gold stainless steel
- Handrail:** Stainless steel round handrail
- Floor:** Standard PVC (optional marble)

FJ-JXA07 (Optional)

- Car ceiling:** Acrylic transparent panel with metallic paint
- Car wall:** Stainless steel hairline and mirror stainless steel etch combination
- Handrail:** Stainless steel flat handrail
- Floor:** Standard PVC (optional marble)

FJ-JXA10 (Optional)

- Car ceiling:** Titanium gold stainless steel frame, acrylic arch top panel
- Car wall:** Titanium gold, mirror, etched, hairline
- Handrail:** Titanium gold stainless steel tube
- Floor:** Standard PVC (optional marble)

FJ-JXA12 (Optional)

- Car ceiling:** Acrylic lighting decoration, stainless steel mirror
- Car wall:** Stainless steel hairline, stainless steel mirror
- Handrail:** Stainless steel hairline
- Floor:** Standard PVC (optional marble)

Note: Pictures have been drawn by computer. It might be slightly different from actual colors. Please take real product as criterion.

Note: Pictures have been drawn by computer. It might be slightly different from actual colors. Please take real product as criterion.

Minimalist Fashion-Model

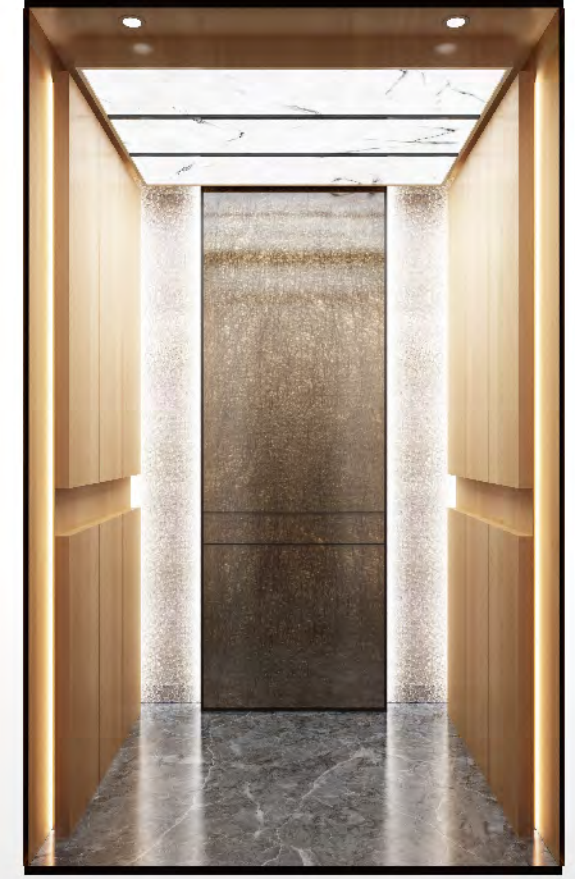
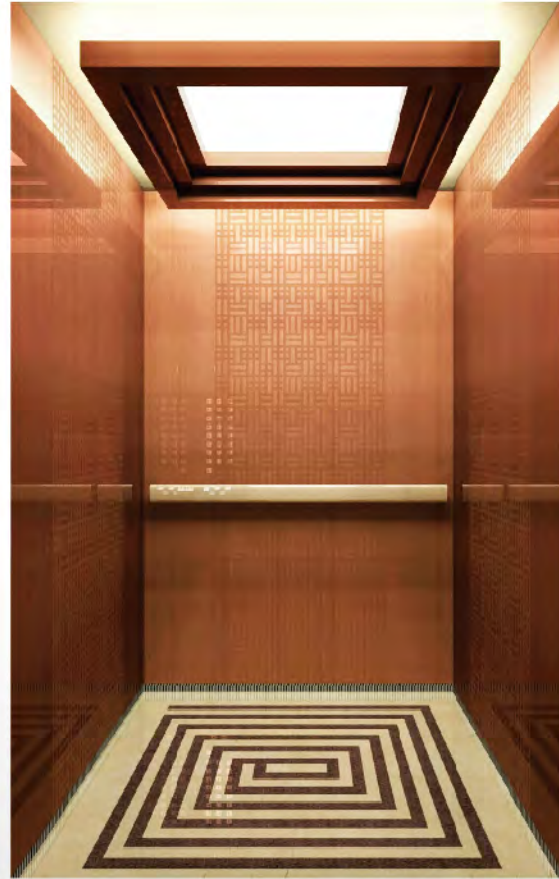

FJ-JXA15 (Optional)

- Car ceiling:** Titanium mirror frame, LED lights belt, LED tube light
- Car wall:** Wood veneer, mirror stainless steel etched titanium plating
- Handrail:** Titanium coating on wood and stainless steel
- Floor:** Standard PVC (optional marble)

FJ-JXA16 (Optional)

- Car ceiling:** The wooden frame, LED lighting
- Car wall:** Bronze hairline and hairline etching plating bronze combinations
- Handrail:** Stainless steel handrail
- Floor:** Standard PVC (optional marble)

FJ-JXA17 (Optional)

- Car ceiling:** The wooden frame, white acrylic pervious to light
- Car wall:** Wood veneer, back wall glass in the middle
- Floor:** Standard PVC (optional marble)

FJ-JXA18 (Optional)

- Car ceiling:** On both sides of the front LED light, middle stainless steel mine, white acrylic pervious to light
- Car wall:** After middle wall art glass, acrylic modelling, on both sides hide light, on both sides of the middle wood veneer, waist line of a concave, hidden lights
- Floor:** Standard PVC (optional marble)

Note: Pictures have been drawn by computer. It might be slightly different from actual colors. Please take real product as criterion.

Note: Pictures have been drawn by computer. It might be slightly different from actual colors. Please take real product as criterion.

Luxury Classic-Manner



FJ-JXA19 (Optional)

- Car ceiling:** Four side LED light, imitation bronze, stainless steel LED lamp belt
- Car wall:** On both sides of the imitation bronze, stainless steel back wall decoration frame, LED lights belt, hidden lights
- Floor:** Standard PVC (optional marble)

FJ-JXA20 (Optional)

- Car ceiling:** Among threads to steel, white colour steel plate model, hide inside and outside lights
- Car wall:** After middle wall white colour modelling, the internal fritillaria hidden lights, wood veneer wall glass mirror, titanium hair around the borders, on both sides of the wood veneer
- Handrail:** Titanium, log armrest
- Floor:** Standard PVC (optional marble)

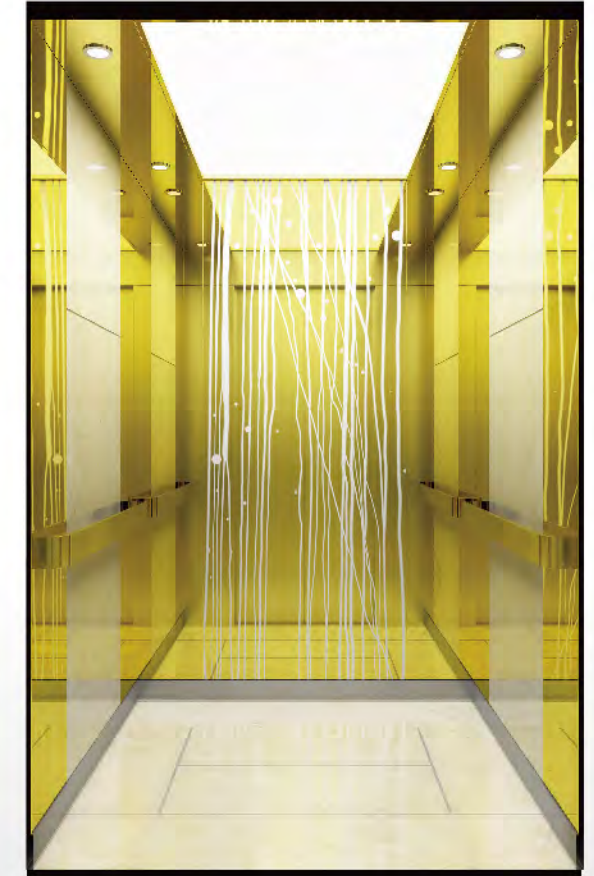

FJ-JXA21-1 (Optional)

- Car ceiling:** Titanium mirror stainless steel, on both sides of the LED light, middle wide dome light
- Car wall:** Three side of the center plate for the titanium surface of stainless steel, the rest of the titanium hairline stainless steel
- Handrail:** Titanium gold stainless steel tube
- Floor:** Standard PVC (optional marble)

FJ-JXA23 (Optional)

- Car ceiling:** Titanium mirror stainless steel, on both sides of the LED light, middle white acrylic pervious to light
- Car wall:** After middle wall mirror etched stainless steel, on both sides of the middle imitation marble tile, the rest of the titanium mirror stainless steel
- Handrail:** Titanium gold stainless steel
- Floor:** Standard PVC (optional marble)

Note: Pictures have been drawn by computer. It might be slightly different from actual colors. Please take real product as criterion.

Note: Pictures have been drawn by computer. It might be slightly different from actual colors. Please take real product as criterion.

Luxury Classic-Manner

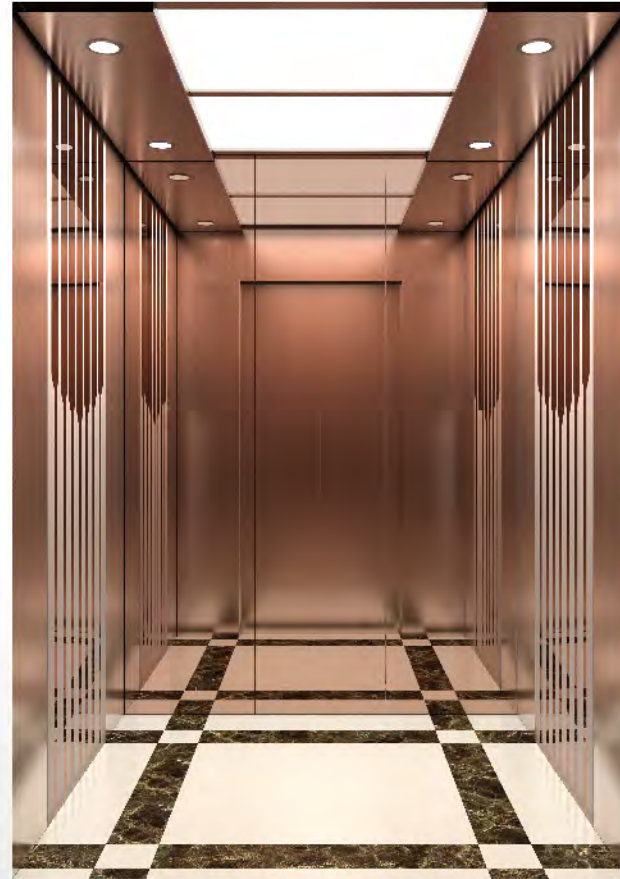

FJ-JXA76 (Optional)

- Car ceiling:** Titanium mirror stainless steel, acrylic, tube lamp
- Car wall:** Titanium hairline stainless steel, titanium mirror etching
- Handrail:** Titanium gold stainless steel
- Floor:** Standard PVC (optional marble)

FJ-JXA78 (Optional)

- Car ceiling:** Mirror stainless steel, acrylic, tube lamp
- Car wall:** Champagne gold, mirror, etching
- Floor:** Standard PVC (optional marble)

FJ-JXA80 (Optional)

- Car ceiling:** Rose gold mirror hollow shape, white transparent board, LED downlight
- Car wall:** Rose gold mirror etching, rose gold handrail, back wall rose gold mirror
- Floor:** Standard PVC (optional marble)

FJ-JXA81 (Optional)

- Car ceiling:** Titanium mirror frame, organic color board, LED downlight
- Car wall:** Titanium mirror etching, titanium hairline
- Handrail:** Titanium gold round handrail
- Floor:** Standard PVC (optional marble)

Note: Pictures have been drawn by computer. It might be slightly different from actual colors. Please take real product as criterion.

Note: Pictures have been drawn by computer. It might be slightly different from actual colors. Please take real product as criterion.

Luxury Classic-Manner

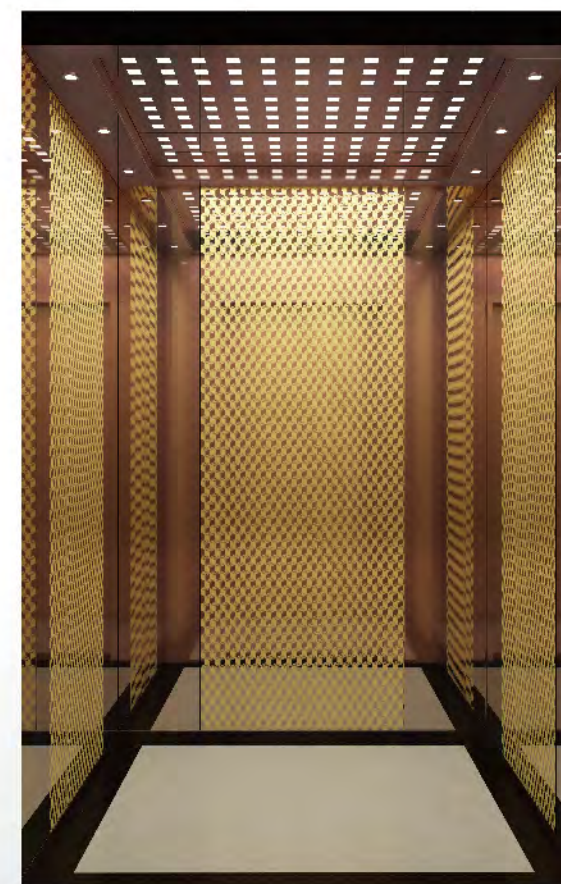
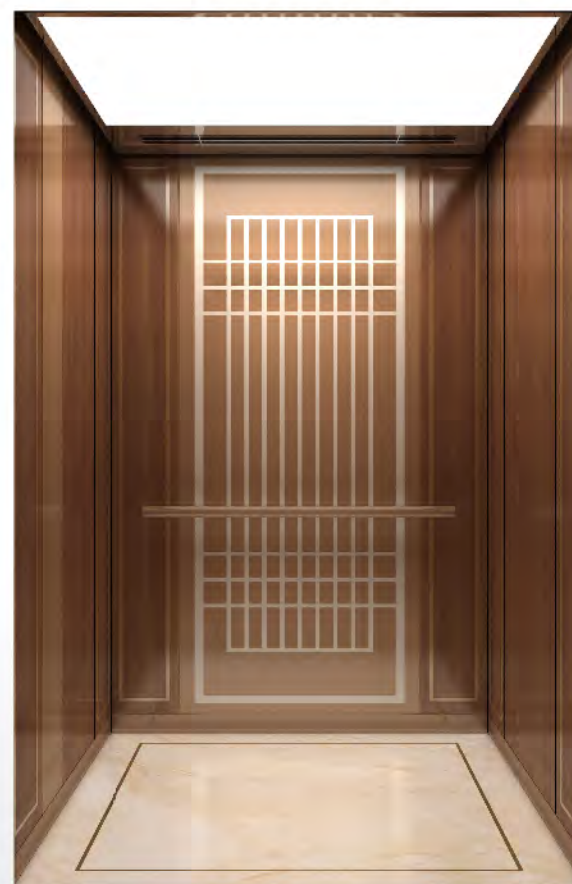
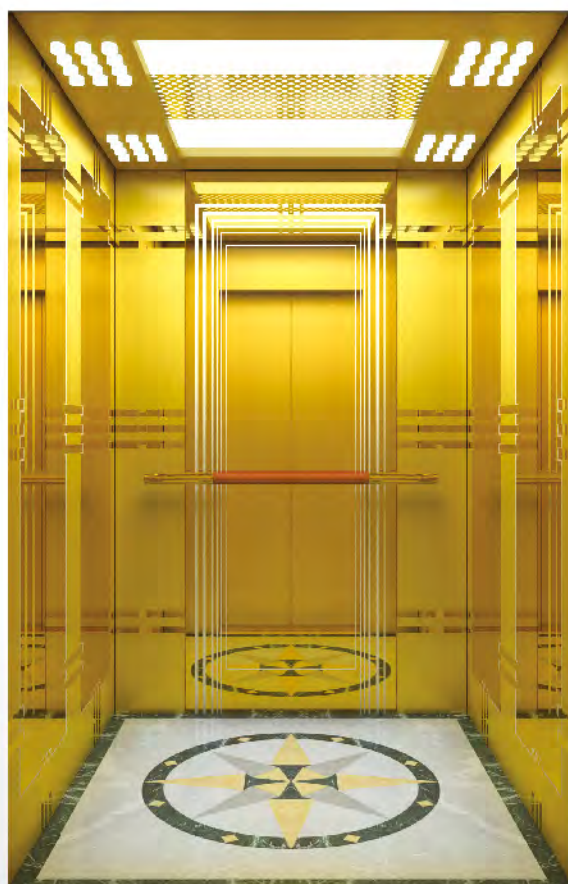

FJ-JXA82 (Optional)

- Car ceiling:** Titanium gold brushed stainless steel frame, acrylic lighting decoration
- Car wall:** Titanium mirror etching
- Handrail:** Combination of round wood and titanium gold
- Floor:** Standard PVC (optional marble)

FJ-JXA83 (Optional)

- Car ceiling:** Bronze mirror frame, white transparent plate
- Car wall:** Walnut wood veneers, bronze brushed etched
- Handrail:** Bronze handrail stainless steel round handrail
- Floor:** Standard PVC (optional marble)

FJ-JXA84 (Optional)

- Car ceiling:** Rose gold mirror craft, acrylic transparent plate, LED lights
- Car wall:** Titanium mirror etching, rose gold mirror
- Floor:** Standard PVC (optional marble)

FJ-JXA85 (Optional)

- Car ceiling:** Titanium stainless steel mirror frame with acrylic translucent panel
- Car wall:** Titanium stainless steel mirror etching in the middle, and titanium hairline stainless steel on two sides
- Floor:** Standard PVC (optional marble)

Note: Pictures have been drawn by computer. It might be slightly different from actual colors. Please take real product as criterion.

Note: Pictures have been drawn by computer. It might be slightly different from actual colors. Please take real product as criterion.

Bed Elevator

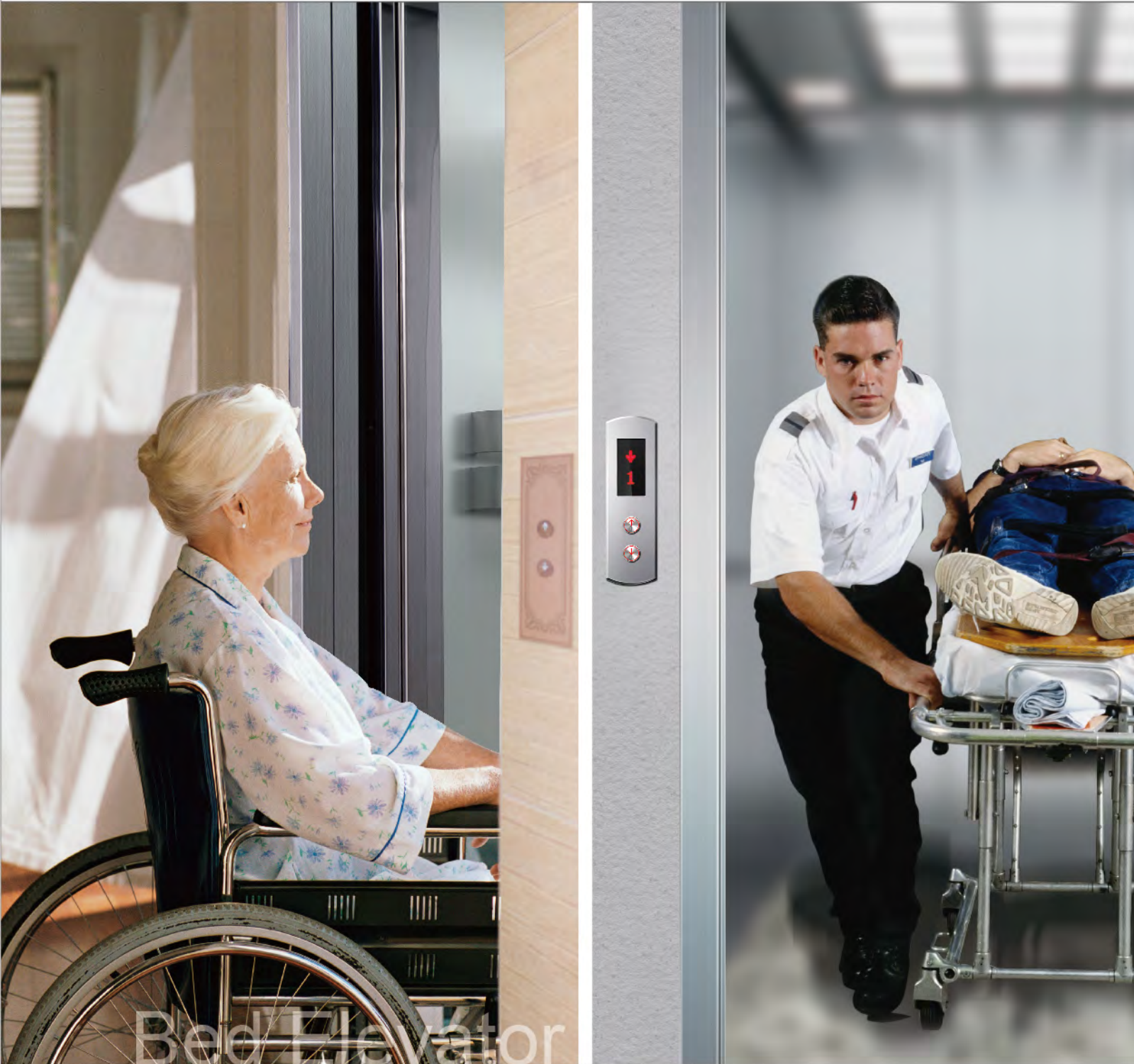

Operation Panel



HD-C04

Bed elevator often competes with time in vast hospitals, modern medical treatment centers, sanatoriums, medi-care centers etc. where healing the wounded and rescuing the dying are the bounden duties. FUJI bed elevator series adhere to the persistently humane thinking, apply fuzzy logic and group supervision technology from expert system, fulfill the intellectual elevator travel and reduce the patients' waiting period to minimum extent.



HD-B01 (Standard)

- Ceiling** Hairline stainless steel, Vaulted light board with acrylic (HD-DTA07)
- Car wall** Hairline stainless steel
- Handrail** Stainless steel flat handrail
- Floor** Standard PVC (optional marble)



HD-B02 (Optional)

- Ceiling** Painted steel with decorative lighting
- Car wall** Painted steel (Cream colored, HD-07)
- Handrail** Stainless steel tube
- Floor** Standard PVC (optional marble)

Note: Pictures have been drawn by computer. It might be slightly different from actual colors. Please take real product as criterion.

Villa Elevator



FUJI villa elevator adheres to the design idea of environmental protection and energy-saving and merges with the latest elevator technology nowadays in order to ensure the safe and reliable products, the comfortable travel. The elegantly designed car, fine and exquisite craft and techniques show the outstanding properties and charm of FUJI villa elevator.

"The journey scene" matches perfectly with the deluxe and fashionable villa. It is so comfortable and convenient in using FUJI villa elevator. You will enjoy your noble life as well.

Range of Application



Features of villa elevator

1. It does not need traditional machine-room, thus reducing construction costs.
2. Traction ratio of 1:1 or 2:1 is special designed for villa elevator.
3. Adoption of sliding or trolley wheel composite guide shoes.
4. Dedicated traction machine frame is used to fasten guide rail.
5. Dedicated door machine, belt drive, CE certification by TÜV.
6. Meeting home elevator national standards GB/T21739-2008.

Various open modes provide easy operation

Various open modes for customers to choose, meanwhile, personalized mode can be designed according to customer requirements for usage.

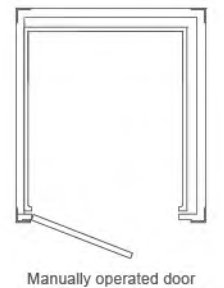

Villa Elevator Car Decoration



FJ-C05



HD-DTA05

Mirror stainless steel framework, acrylic arch paint-jet top plate in the middle and acrylic lighting decoration on both sides



FJ-X05A

No bottom box calling (simplex)

FJ-V01 (Standard) <<<

- Car ceiling** HD-DTA05
- Car wall** Stainless steel hairline on both sides, combination of stainless steel hairline and etched mirror at rear wall
- Floor** Standard PVC (optional marble) (FJ-B01)

Note: Pictures have been drawn by computer. It might be slightly different from actual colors. Please take real product as criterion.

Optional Car Decoration



FJ-V02

- Ceiling** Mirror stainless steel, luminescent micaex, LED
- Car wall** Hairline stainless steel, titanium mirror stainless steel
- Floor** Standard PVC (optional marble)

Note: Pictures have been drawn by computer. It might be slightly different from actual colors. Please take real product as criterion.



FJ-V03

- Ceiling** Painted steel plate, down light
- Back wall** Wood veneer, canvas, light decoration
- Side wall** Titanium mirror stainless steel
- Floor** Standard PVC (optional marble)

Villa Elevator Decoration Series

Optional Car Decoration



FJ-V04

- Ceiling** Hairline stainless steel, acrylic light-transmitting plate, LED light
- Car wall** Hairline stainless steel, sightseeing glass
- Handrail** Stainless steel single tube
- Floor** Standard PVC (optional marble)



FJ-V05

- Ceiling** Titanium mirror stainless steel frame, LED lighting
- Car wall** White wood veneer, personalized beauty mirror
- Floor** Standard PVC (optional marble)



FJ-V06

- Ceiling** Stainless steel frame, LED tape hidden around, mirror stainless steel in the middle
- Car wall** Color grain makeup plate, mirror stainless steel, imitation marble makeup plate
- Floor** Standard PVC (optional marble)

Operation Panel Series



FJ-VC03
Optional

Optional touch screen



FJ-TC01



FJ-TC03



FJ-VC04
Optional



FJ-VZ03
Optional

Handrail type floor selection style



FJ-HT01

Optional outbound call



FJ-VZ05
Optional



FJ-VZ08
Optional



FJ-VZ09
Optional



FJ-VZ10
Optional



FJ-VZ11
Optional

Note: Pictures have been drawn by computer. It might be slightly different from actual colors. Please take real product as criterion.

Note: Pictures have been drawn by computer. It might be slightly different from actual colors. Please take real product as criterion.

Observation Elevator

Standard Configuration



The unique design fulfills charm grace and conciseness. Permeable luminance produces a sweet and bright atmosphere in the whole car reinforcing the overall space inside car, decent & harmonious.

HD-GA01 >>>

Upper / lower hood

Painted steel

Panorama wall

180° circular safety laminated glass

Decorative top

Painted steel framework, acrylic arch top plate

Car wall

Hairline stainless steel

Car door

Hairline stainless steel

Handrail

Stainless steel tube

Floor

Standard PVC (optional marble)

Not only observation elevator glass steel structure perfect development compact space and whole artistic. Also may act according to the different construction to design, the convenience is quick, all uses the circular generally, the semicircle and the square shape.

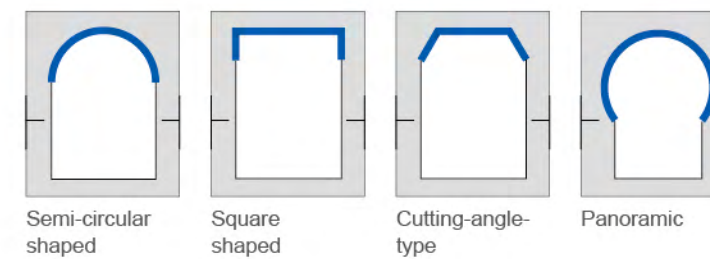

Observation Elevator

Note: Pictures have been drawn by computer. It might be slightly different from actual colors. Please take real product as criterion.

Observation Elevator

»» HD-GA02 (Optional)

Upper / lower hood: Painted steel
Panorama wall: Safety laminated glass
Decorative top: Painted steel framework, acrylic lighting decoration board, acrylic strip lighting decoration
Car wall: Hairline stainless steel
Car door: Hairline stainless steel
Handrail: Stainless steel double-tube
Floor: Standard PVC (optional marble)



«« HD-GA03 (Optional)

Upper / lower hood: Mirror stainless steel press sill, red acrylic decoration cover
Panorama wall: Safety laminated glass
Decorative top: Painted steel framework, acrylic lighting decoration
Car wall: Hairline stainless steel
Car door: Hairline stainless steel
Handrail: Stainless steel double-tube
Floor: Standard PVC (optional marble)



Note: Pictures have been drawn by computer. It might be slightly different from actual colors. Please take real product as criterion.

»» HD-GA04 (Optional)

Upper / lower hood: Painted steel, acrylic decoration
Panorama wall: Laminated glass three pieces
Decoration top: Painted steel, acrylic floor
Car wall: Hairline stainless steel
Car door: Hairline stainless steel
Handrail: Stainless steel round tube
Floor: Standard PVC (optional marble)



«« FJ-GA10 (Optional)

Upper / lower hood: Ivory acrylic
Panorama wall: Laminated glass
Decoration top: Steel plate of the lacquer that bake, mirror stainless steel, lamp act the role ofing
Car wall: Titanium hair grain stainless steel
Car door: Framed glass door
Handrail: Stainless steel round tube
Floor: Standard PVC (optional marble)



Note: Pictures have been drawn by computer. It might be slightly different from actual colors. Please take real product as criterion.

Minimalist Fashion-Model



FJ-GA01 (Optional)

Upper / lower hood: Mirror stainless steel
Car ceiling: Mirror stainless steel frame, top plate LED light
Car wall: Safety glass, mirror stainless steel
Car door: Framed glass door
Handrail: Stainless steel round tube
Floor: Standard PVC (optional marble)

»» FJ-GA02 (Optional)

Upper / lower hood: Titanium gold mirror
Panorama wall: Laminated glass(3PCS combination)
Decoration top: Titanium gold mirror, acrylic lighting decoration
Car wall: Titanium gold mirror
Car door: Titanium mirror framed glass door
Handrail: Titanium gold handrail
Floor: Standard PVC (optional marble)



«« FJ-GA03 (Optional)

Upper / lower hood: Stainless steel hairline, LED lamp
Panorama wall: Laminated glass(3PCS combination)
Decoration top: The steel plate baked enamel, acrylic lighting decoration
Car wall: Stainless steel hairline
Car door: Hairline stainless steel
Handrail: Stainless steel handrail
Floor: Standard PVC (optional marble)



Note: Pictures have been drawn by computer. It might be slightly different from actual colors. Please take real product as criterion.

Note: Pictures have been drawn by computer. It might be slightly different from actual colors. Please take real product as criterion.

Minimalist Fashion-Model

»» FJ-GA04 (Optional)

- Upper / lower hood:** Stainless steel hairline, stainless steel mirror
- Panorama wall:** Laminated glass(3PCS combination)
- Decoration top:** Stainless steel frame, glass, lamp with, down lamp
- Car wall:** Stainless steel mirror frame, frosted glass, lamp with
- Car door:** Hairline stainless steel
- Handrail:** Stainless steel round tube
- Floor:** Standard PVC (optional marble)



«« FJ-GA05 (Optional)

- Upper / lower hood:** Painted steel
- Panorama wall:** Laminated glass (3PCS combination)
- Decoration top:** Stainless steel mirror top plate, acrylic lighting decoration
- Car wall:** Laminated glass
- Car door:** Hairline stainless steel
- Handrail:** Stainless steel tube
- Floor:** Standard PVC (optional marble)

Note: Pictures have been drawn by computer. It might be slightly different from actual colors. Please take real product as criterion.

»» FJ-GA06 (Optional)

- Upper / lower hood:** Painted steel
- Panorama wall:** Laminated glass
- Decoration top:** Painted steel framework
- Car wall:** Hairline stainless steel
- Car door:** Hairline stainless steel
- Handrail:** Stainless steel tube
- Floor:** Standard PVC (optional marble)



«« FJ-GA07 (Optional)

- Upper / lower hood:** Painted steel
- Panorama wall:** Glue glass of safety clamp 6+6
- Decoration top:** Painted steel framework
- Car wall:** Hairline stainless steel
- Car door:** Hairline stainless steel
- Handrail:** Stainless steel tube
- Floor:** Standard PVC (optional marble)

Note: Pictures have been drawn by computer. It might be slightly different from actual colors. Please take real product as criterion.



Standard Configuration

Operation Panel

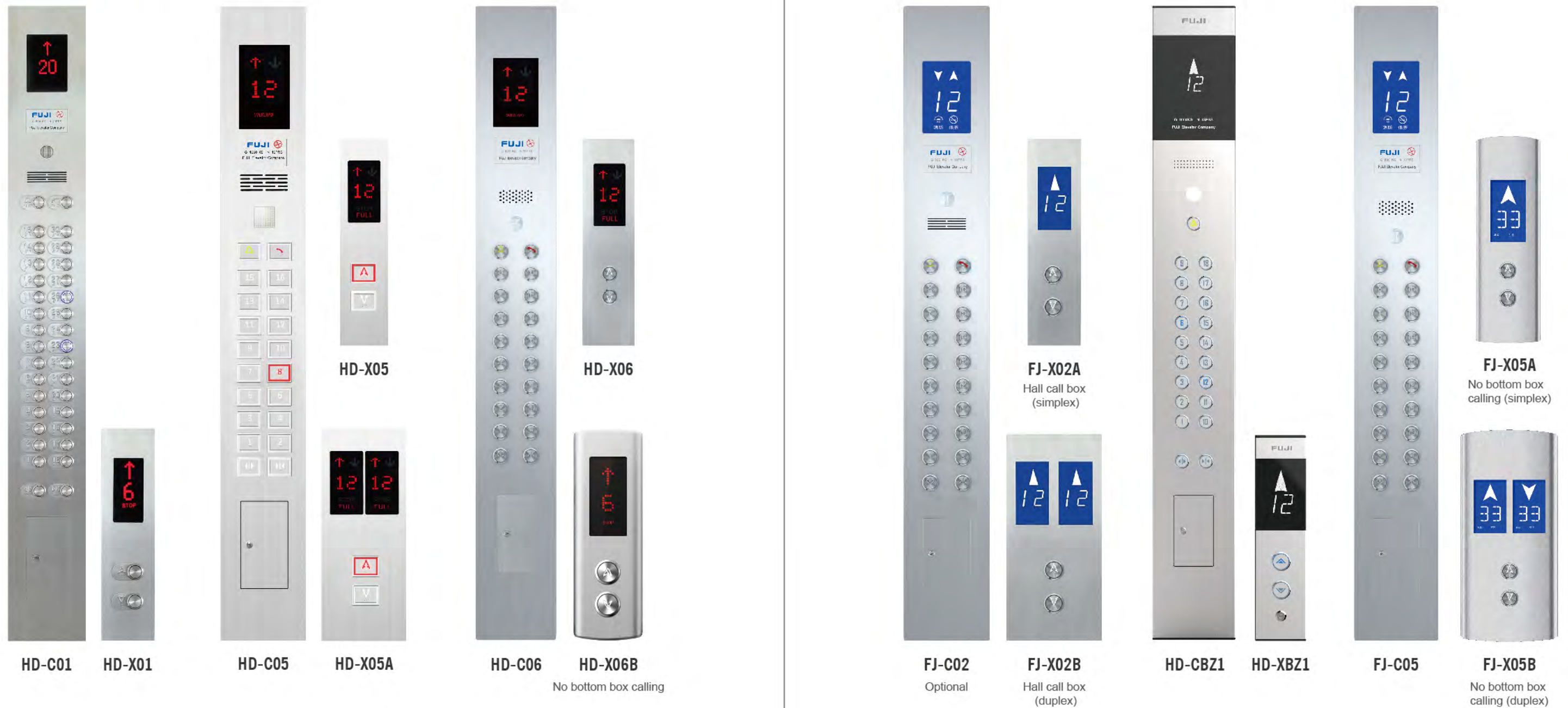

Note: Pictures have been drawn by computer. It might be slightly different from actual colors. Please take real product as criterion.

Note: Pictures have been drawn by computer. It might be slightly different from actual colors. Please take real product as criterion.

Operation Panel Decoration(Optional)

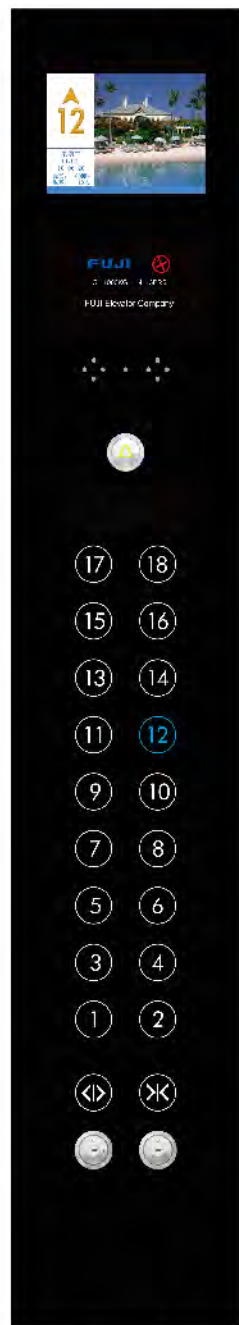

FJ-C04
Touch Operation Panel

Material
Black glass touch
operation panel

**Touch calling
box(Simplex)**



FJ-X04A



FJ-C06

Material
Black Titanium-gold

**Hall call box
(simplex)**



FJ-X06A

**Hall call box
(duplex)**

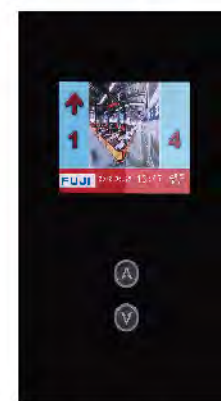

FJ-X06B



HD-CBZ5
Optional



HD-XBZ5



HD-XBZ5A
No bottom box calling

Multimedia display of COP (Optional)



FFA-YD360-7B



FFA-YD360-8C



FFA-YD360-104C

C.O.P for the disabled



HD-C04

Hall indicator



FJ-LCDA

**Hall call box
(no indicator)**



FJ-LCDB

Color of button lamp ring



Note: Pictures have been drawn by computer. It might be slightly different from actual colors.
Please take real product as criterion.

Note: Pictures have been drawn by computer. It might be slightly different from actual colors.
Please take real product as criterion.

Front wall integrated operation panel (optional) / fault code display,
optional dot matrix

Operation Panel Decoration(Optional)

Material
Titanium gold
stainless steel mirror



FJ-C03



FJ-X03A



FJ-X03B

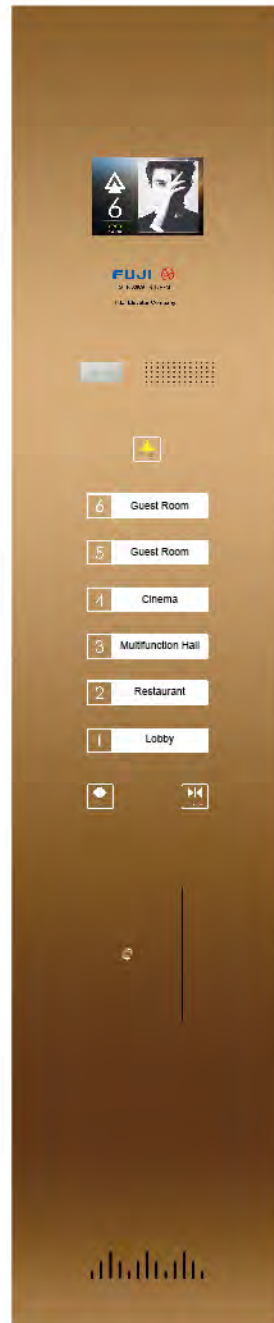

FJ-C15



FJ-X15A



FJ-X15B



FJ-C17

Touch Operation panel



FJ-X17D



FJ-X17A



FJ-C18

Touch Operation panel



FJ-X18D



FJ-X18A

Note: Pictures have been drawn by computer. It might be slightly different from actual colors.
Please take real product as criterion.

Note: Pictures have been drawn by computer. It might be slightly different from actual colors.
Please take real product as criterion.

Operation Panel Decoration(Optional)

Floor Decoration PVC (Optional Marble)



FJ-BCK411



FJ-KXG811



FJ-BCK481



FJ-BSK481



FJ-BXK481



FJ-BXK481



FJ-B01(PVC)
FJ-B01D(Marble)



FJ-B02(PVC)
FJ-B02D(Marble)

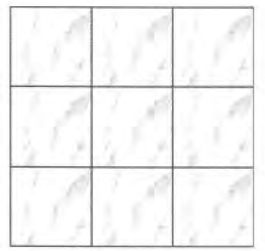

FJ-B09(PVC)
FJ-B09D(Marble)



FJ-B10(PVC)
FJ-B10D(Marble)

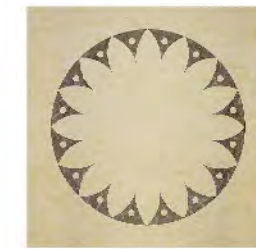

FJ-B12(PVC)
FJ-B12D(Marble)



FJ-B16(PVC)
FJ-B16D(Marble)



FJ-B18(PVC)
FJ-B18D(Marble)



FJ-B19(PVC)
FJ-B19D(Marble)



FJ-B20(PVC)
FJ-B20D(Marble)

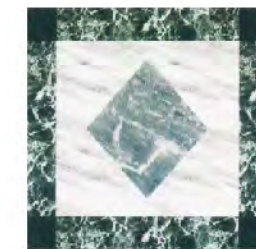

FJ-B23(PVC)
FJ-B23D(Marble)



FJ-B26(PVC)
FJ-B26D(Marble)



FJ-B80(PVC)
FJ-B80D(Marble)



FJ-B81(PVC)
FJ-B81(Marble)



FJ-B82(PVC)
FJ-B82D(Marble)



FJ-B83(PVC)
FJ-B83D(Marble)

Note: Pictures have been drawn by computer. It might be slightly different from actual colors. Please take real product as criterion.

Ceiling series



HD-DTA01
Diamond silver painted steel with acrylic photic board



HD-DTA02
Mirror stainless steel framework, acrylic arched top plate



HD-DTA03
Stainless steel mirror base-plate is supplemented by rectangle hollow transparent light pole. The soft lighting design of arched white light-passing board is in the middle part

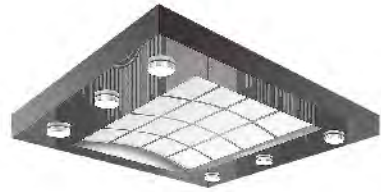

HD-DTA05
Mirror stainless steel framework, acrylic arch paint-jet top plate in the middle acrylic lighting decoration on both sides



HD-DTA06
Mirror stainless steel framework, acrylic pillar, diverse lighting board



HD-DTA07
Hairline stainless steel, vaulted light board with acrylic



HD-DTA09
Acrylic transparent panel with metallic paint



HD-DTA10
Black titanium mirror stainless steel frame, down lamp, top panel LED discolor lighting



HD-DTA11
Acrylic lighting decoration, stainless steel mirror

Note: Pictures have been drawn by computer. It might be slightly different from actual colors. Please take real product as criterion.



HD-DTA12
Acrylic lighting decoration, stainless steel hairline, down lamp



HD-DTA14A
Mirror stainless steel frame, lamp belt, LED lighting



HD-TDA22
Mirror stainless steel frame, acrylic, down light



HD-TDA23
Mirror stainless steel with acrylic photic board



HD-TDA47
Mirror stainless steel with acrylic photic board



HD-TDA52
Titanium mirror stainless steel frame, lamp belt, LED lighting



HD-DDB01
Hairline stainless steel, down lamp lighting

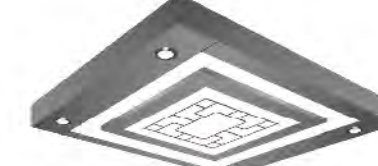

HD-DDB02
Vortical square image main body board and tube lamp combining for soft illumination design



HD-DT01
Steel plate plastic jetting frame with acrylic lighting cover. Intermediate circular translucent lighting is used.



HD-DT13
Stainless steel frame in middle, white transparent board on both sides of the soft lighting design, two sides made of stainless steel

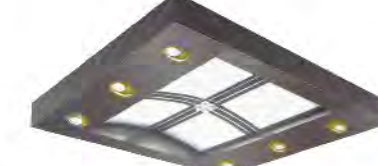

HD-DT09
Mirror frame, supplemented by leds on mirror stainless steel plate, the middle section is arched white plate light lighting design

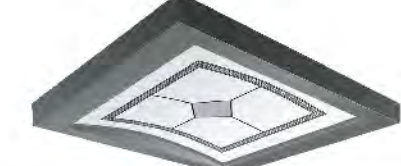

HD-DT11
Mirror frame, supplemented by leds on mirror stainless steel plate, the middle section is arched white plate light lighting design

Note: Pictures have been drawn by computer. It might be slightly different from actual colors. Please take real product as criterion.

Decoration Series

Handrail Optional



FJ-FS01
Stainless steel handrail



FJ-FS02
Stainless steel double-tube handrail



FJ-FS03
Titanium-gold and stainless steel handrail base, central material is solid wood



FJ-FS04
Stainless steel flat handrail



FJ-FS05
Titanium-gold mirror stainless steel, central material is acrylic

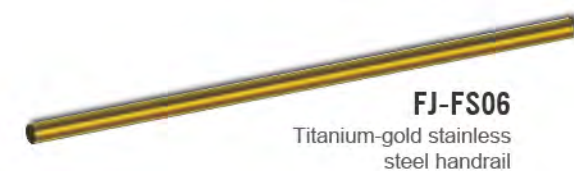

FJ-FS06
Titanium-gold stainless steel handrail

Direction lantern



FJ-DL01



FJ-DL02



FJ-DL03



FJ-DL04



FJ-DL05



FJ-DL07

Optional Colors

Note: There might be slight difference between the samples and real products, please take the real products as criterion.

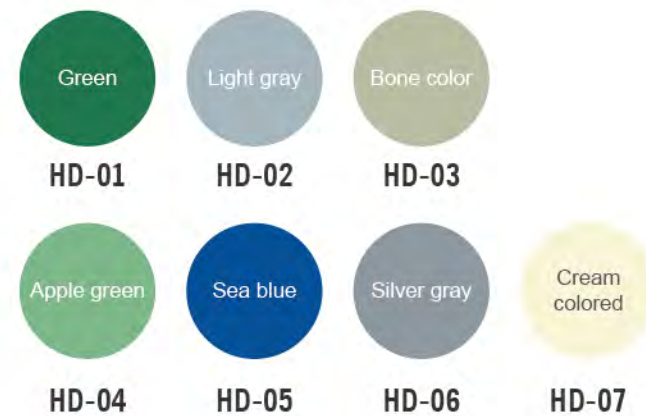

Car Decoration



Painted steel <
HD-02, Light gray

Car ceiling HD-DTA01 (Painted steel: HD-02, Light gray)

Car wall Painted steel: HD-02, Light gray

Floor PVC; FJ-B01

Car door Painted steel: HD-02, Light gray

Painted steel >
HD-03, Bone

Car ceiling HD-DTA01 (Painted steel: HD-03, Bone)

Car wall Painted steel: HD-03, Bone

Floor PVC; FJ-B02

Car door Painted steel: HD-03, Bone

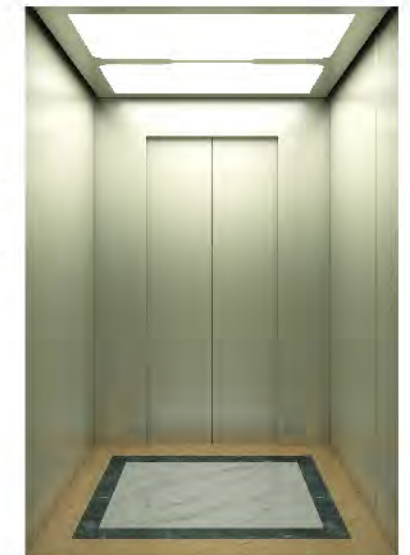

Landing Door Decoration(Optional)



Glass Door: Frameless

Stainless steel frame: upper and lower



Glass Door: Full Frame

Stainless steel frame: Four Sides



Painted Steel Door

HD-03, Bone

Note: Pictures have been drawn by computer. It might be slightly different from actual colors. Please take real product as criterion.

Landing Door Decoration(Optional)

Note: Pictures have been drawn by computer. It might be slightly different from actual colors. Please take real product as criterion.



FJ-MM01
Mirror, etched, stainless steel
(optional titanium gold mirror, etched)



FJ-MM02
Mirror, etched



FJ-MM03
Mirror, etched



FJ-MM21
Rose gold mirror, etched



FJ-MM22
Rose gold mirror, etched



FJ-MM23
Titanium gold, mirror, etched



FJ-MM04
Mirror, etched



FJ-MM05
Mirror, etched



FJ-MM06
Mirror, etched



FJ-MM24
Titanium gold, mirror, etched



FJ-MM25
Titanium gold, mirror, etched



FJ-MM26
Titanium gold, mirror, etched

Gear Freight Elevator



Gear Freight



Large carrying capacity

FUJI Elevator Have gear freight elevator combined with elevator engineering technology and other top technology, strong drive system, high strength of the mechanical structure design, not only can accommodate heavy goods, and can operation in a variety of harsh environments. It has the advantages of high transmission efficiency, low noise, flat layer precision and so on. In the energy saving control system the large carrying capacity, can also achieve energy saving. This elevator is widely used in factories, warehouses, shopping malls and other cargo places.

Gearless Freight Elevator



Gearless Freight

- Excellent quality
- Energy efficient
- Green environmental protection



FUJI Elevator gearless freight elevator is using high-tech permanent magnet synchronous gearless machine drive technology, which is leading the trend of the times. The host size is small, space-saving construction, significant energy efficiency, low noise operation with carrier-class quality, security and technology is a combination of classic, it can be widely used in factories, shopping malls and other cargo places.

Machine Roomless (MRL) Freight Elevator

FUJI Elevator series MRL freight elevator, using the advanced permanent magnet synchronous gearless traction technology, reasonable design, without room; the traction machine has the advantage of light weight, small volume saving the architectural space, greatly improve the performance and quality of machine roomless elevator, reduce energy consumption, the failure rate. FUJI Elevator series MRL freight elevator with less shaft height, reduce the design height of the factories and other buildings, can meet the actual needs of the enterprise. To be the best choice for the transportation of goods, such as factories, warehouses, department stores, property centers, libraries and so on.

- Space saving
- Energy saving advantage
- Quiet operation

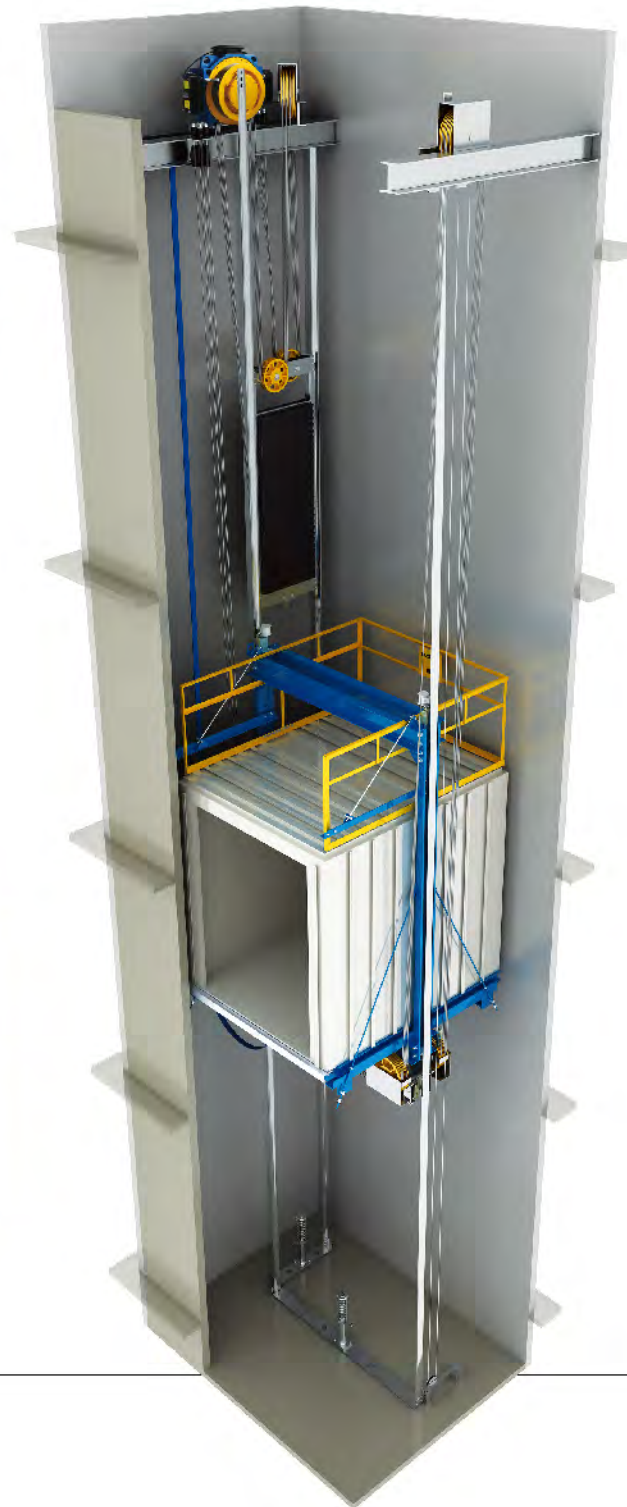
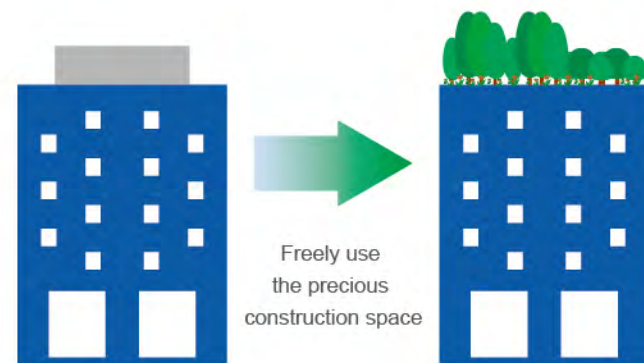

Explosion-proof Freight Elevator



FUJI Elevator series explosion-proof freight elevator on the design principle and security aspects of strict implementation of national standards, to fully meet the needs of a variety of harsh place, in addition to have 1000kg, 3200kg of explosion-proof elevator production license and relevant industry explosion permit, more from the perspective of the user environment and feelings of departure, and strive to achieve the perfect combination of safety and practical. Suitable for hazardous area locations with explosive gas and dust.

- Aluminum alloy control cabinet is convenient and green.
- The flexible arrangements of machine room do not demand much of the construction layout.
- Explosion-proof form: Ex • d [ib] • II • BT4 • Gb, flameproof and intrinsically safe.



Hydraulic Elevator



Hydraulic elevator is special type elevator which has different travelling way from others. It has its own unique advantageous performance and applicability. FUJI hydraulic elevator adopts the hydraulic pump and hydrocylinder with the high quality and performance. It brings about an extremely quiet and smooth elevator running. It also utilizes the multiple security means such as safety valve of protection system the anti-stalling device, one-way valve which prevents from the return flow of the hydraulic oil, etc.

The diversified lifting modes

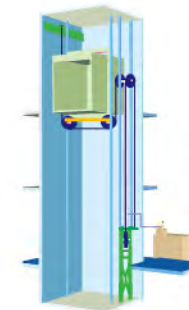

Single-cylinder side action type 4 : 2



Double-cylinder side action 2 : 1

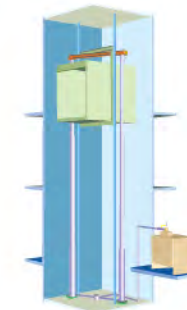

Double-cylinder side action direct drive 1 : 1

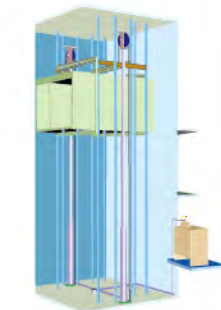

Double-cylinder side action 6-rail 2 : 1

Single-cylinder side action type 4 : 2

Under this lifting mode, the elevator can thoroughly solve the unbalanced loading to the traditional rucksack hydraulic system guide-rail. It greatly improves the comfort-ness of the elevator start & brake. It is especially suitable for the elevators with large hoisting height and small rated carrying weight.

Double-cylinder side action direct drive 1 : 1

Two rows of oil cylinder with symmetrical arrangement directly connect with upper beam of the car. Under this lifting mode, the elevator gets the concise structure and the high safety coefficient. It is especially suitable for the elevators with the low elevator height and medium rated carrying weight.

Double-cylinder side action 2 : 1

Under the linkage elevator configurations of two rows of oil cylinder and pulley block combination with symmetrical arrangement, all the car loads will be borne by two rows of oil cylinders. Therefore we can reduce the shaft wall force. It is especially suitable for the elevators with large hoisting height and medium rated load.

Double-cylinder side action 6-rail 2 : 1

Under this lifting mode, all of the elevator car load will be borne by oil cylinder. Therefore we have low requirements towards the hoistway structure. Whereas car guide-rail system is composed of 6 rows of rigid guide-rails, it ensures the car rigidity requirements and fine stability in transport travel even the elevator is in the unbalanced load conditions. The rated carrying load reaches as high as 5000kg. It is especially suitable for the concentrated load elevators with medium travel height and heavy rated load.

Hydraulic Elevator

Car Elevator

Freight Elevator Car Decoration



With economic development, people's living quality is keeping to improve, the car gradually into the homes of ordinary families. FUJI Elevator series car elevator, make full use of FUJI Elevator years car elevator technology, combined with the domestic market and the development of the machine room car elevator and machine roomless car elevator.

FUJI Elevator machine room car elevator sare using the latest VVVF technology dedicated to the transport car elevator and overall elevator system to improve floor less restricted, and ensure the millimeter accurate flat layer, comfortable, low noise, technology innovation, further reducing the energy consumption of more than 30%.

FUJI Elevator machine roomless car elevator are using machine roomless configuration, under special circumstances provides a flexible solution for designers. The intelligent microcomputer control system, high strength and strong design, avoided by car to uneven traction system load increase and produce noise and capsules jitter, make the discrepancy of the car more safe. Car elevator is widely used in the parking lot, garage, underground garage and other places.

»»» HD-H01 Standard Configuration

Car wall	Painted steel
Ceiling	Painted steel
Lighting	Fluorescent lamp
Car door	Painted steel
Flooring	Checked steel plate



»»» HD-H02 Optional Configuration

Car wall	Hairline stainless steel
Ceiling	Hairline stainless steel
Lighting	Fluorescent lamp
Car door	Hairline stainless steel
Flooring	Checked steel plate



The pictures are plotted by computer and are likely somewhat different from the actual products.

Freight Elevator Decoration

Hall door series



Center opening



Side opening



Double-folded center opening type



3-folded center opening type

Control operation panel and hall buttons

Simple and elegant buttons handling facility, matching the diversified and personalized cabin to a greater extent.



HD-C05

HD-X05

FJ-C05

FJ-X05A

No bottom box calling (simplex)

Floor optional

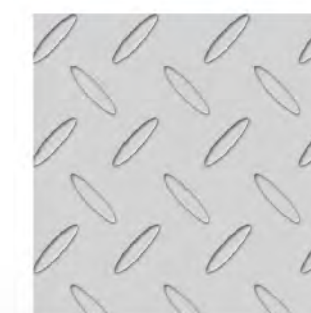

HD-HDB01
Checked steel plate

Optional crash barrier



Wooden



Black rubber

The pictures are plotted by computer and are likely somewhat different from the actual products.

Dumbwaiter Elevator



It is widely applicable to places like hotel, restaurants, banks, hospitals, libraries and laboratories and so on to transport food, drinking, money, files, medicine, books, instruments and so on with advantages like small size and highly efficient transportation.

Free and flexible, machine room structure

Civil well with or without machine room can be selected according to structure difference, improve freedom of construction design.

Low malfunction rate, convenient maintenance

Adopt micro computer control with low malfunction rate, convenient maintenance and low cost.

Low energy consumption, energy saving and economical

Mechatronics, simple and flexible operation, low operation energy consumption, energy saving and economical.

Multiple modes customized for you

Choose appropriate door opening modes according to features of goods carrying for convenience of goods entrance.



Ground type (Up and down directly separated)



Window type (Up and down directly separated)



Passenger elevator Function

Standard Function

Full collective control	Controller Will Automatically Select The Nearest Elevator Responding Passenger's Call.
Inspection operation	Automatically Move To The Nearest Leveling In A Slow Speed.
Slow speed running	In normal condition The Elevator will automatically move to the nearest leveling in a slow speed.
Automatic door opening	Elevator open the door automatically.
Automatic door opening time adjustment	Door remaining open for a short time in normal condition.
Door opening button(external)	Door remaining open when the door opening button was pushed on.
Door pre closing function	To make door close immediately in normal opening condition.
Door opening button(internal)	To make door open or re open when elevator stops.
Full load bypass	When the elevator is fully loaded, it will travel to destination without responding to calling outside.
Automatic turn off lighting and fan	Lighting and fan will cut off power automatically without any call or indication in 3 minutes.
Automatic return to home landing	In normal condition, the elevator will return to home landing without any more calls or indications.
Door re closing	The door will try to close again when it is blocked.
Error recording	Mainboard can record 10 errors at most.
Hoistway self learning	Elevator can learn the data and situation automatically before using.
Attendant service	The lift is close by continued pressing close buttons.
Bypass operation	Elevator will travel directly to destination without stopping.
Automatic correction of floor position signal	Self correcting the data when the elevator reach final limit switch.
Lift locking	Lock the elevator and turn off the power so that no one can use it.
Protection of door lockup outside door area	No door opening when it is not in leveling position.
Infrared light curtain protection	Door will opening when it is blocked.
Over load protection	Elevator refuse to travel with buzz when it is overloaded.
Reversal running protection	When the running direction is different with destination direction, it stops automatically.
Anti skip protection	Travelling a long time without door opening, it will stop automatically.
Anti terminal over running protection	There are final limit switch to protect the elevator.
Phase protection	Stop to move when the final limit switch fails to have function.
Phase protection	The elevator will stop with wrong phase or lack phase.
Contact protection	Stop running when safety devices conflict.
Failure analysis of shaft self learn	When the shaft learned by itself that it doesn't finish it correctly.
Motor temperature protection	Protect the motor from being over heat.
Door opening failure protection	Stop running when error happens to door.
Protection for door lock short circuit	Elevator refuse to move when error suddenly happens to the brake.
Door lock failure for brake switches	Elevator will stop at once when error suddenly happens to door lock.
Over speed protection	In case of elevator running too fast.
Contact protection for brake switches	Protect the elevator when error happens to the brake.
Interphone communication	Communication for machineroom, car top, car cage, pit and inspection station.
Wheeling protection	Safety protection in rescuing.
Alarm bell	When the anomaly occurred, passenger in the cabin can notice the outside with this device.
Emergency lighting	When the power supply is failure, it can provide the lighting of the car.
Two doors operator	Only for opening through door opening type.
Level switch protection	It is a safety protection in case of the trouble in leveling switch.
False call canceling	When the passengers press the false button, it can cancel the call through the two times press.
Automatic reversal call canceling	When the running direction is different with destination direction, it stops automatically.
Floor display directional setup	Directional setup of service floor.
Isolate running	Operation similar to attendant service function.

Standard Function

Dot matrix floor indicator	The indicator displayed in matrix type.
Rolling display of running direction	The running direction display in a rolling way.
Forced door closing	The door nudging device will force the door closing when it open too long.
CAN communication protection	Prevent the danger in case of trouble.
Arrival gong	Sound to indicate leveling is finished.
Emergency return in case of fire	The elevator will return to home floor in a short time when fire emergency happens.
Main control protection	Stop the running of the elevator in case of trouble.
Main control CPU WDT protection	When test the trouble of CPU, WDT make it reset.
Discretionary setup of service floor	Using the operator to setup the landing floor discretionarily.
Test running	It is used for testing the new elevator.
Clock control	It can record the time of trouble, and decide to stop at any floor.
Direct landing	The efficiency of the elevator can be improved by the distance principle to deceleration.
Load weighing device	With such system, the elevator can self learn the data to improve the start up.
Parallel control	Two elevator through the CAN serial communication bus to coordinate the call.
Protection device for accidental movement of the car	In case of accidental movement that the car leaves the landing floor while the landing door is unlocked as well as the car door keeps open, protection device to prevent or stop such movement should be equipped.

Optional Function

IC card management	Users can control the certain floors with this card.
Voice announcer	Voice announcement for running situation.
Automatic rescue device(ARD)	The elevator will automatically run to the nearest door zone when the power supply fails.
Advance door opening	In process of leveling, the distance is right, and the speed is little than the regulated one, the door will open in advance.
Arrival forecasting light	Flashing when the elevator is leveling, to remind the passenger that it will landing.
Arrival chime	It can ring when the elevator is landing.
Remote monitoring	It can monitoring the running situation of elevator.
Earthquake function	When the earthquake device is moving, the elevator will landing at the nearest floor, and open the door.
Fireman operation	Firemen can use this elevator to travel to destination without responding to calling outside.
Self re leveling	When the leveling is not accurate, it will re leveling automatically.
Sub control panel	It just like the main accurate, it will re leveling automatically.
Rear car operational panel	It control the rear opening and close.
The handicapped car operational panel	It specially designed for the handicapped people.
Group control	Through the group control to coordinate the running of many elevator.
The service for the rush hour of go to work	Only for group control, when the elevator runs up from home floor with 3 more instructions, and other elevator in response to instructions and calls will automatically return to home floor and open doors.
The service for the rush hour of off work	Only for group control, when the elevator runs comes down from home floor with 3 more instructions, and other elevator in response to instructions and calls will automatically return to home floor and open doors.
Dispersed waiting	Only for group control, when the elevator stops running in a specified time, the elevator will return to the pre setting floor to shorten the call time for various floors to improve efficiency.
Isolated control of front and rear door	There are two kinds: one is the rear car operational board, the other is the call box outside the rear door.
Anti nuisance operation	It can cancel the disturbance instruction.
VIP service	It can cancel all the instruction and call until the VIP arrives the certain stop without any other stop.
Door remaining open function	Keep press the door open button to delay of door closing.
LCD indicator	It can clearly indicate the floors and other information.

Freight elevator Function

Standard Function

Automatic running	When there is no attendant who operate elevator, elevator will run to the destination floor according to the instruction of passengers automatically.
Attendant running	Elevator is operated by attendant, attendant press car calls as request of passengers and elevator will run to the destination floor according to the car calls.
Automatic adjustment of door opening time	According to current registered landing call and call call situation, system will automatically adjust the door open holding time.
Door re-open at same floor	When door is closing, door can re-opened by pushing landing call button at current floor.
Car arrival gong	Arrival gong on the car top advices passengers that elevator arrives.
Car call cancel	If passengers press the wrong floor button in car, same button press it again can cancel the wrong register.
Parking	When electric key switch is turn off, elevator enters into parking state, it will not serve to any landing call.
Protection device for accidental movement of the car	In case of accidental movement that the car leaves the landing floor while the landing door is unlocked as well as the car door keeps open, protection device to prevent or stop such movement should be equipped.
Light curtain protection	When light curtain is sheltered, door will stop closing at once and automatically open.
Overload stop	When elevator is overload, elevator door keeps opening, buzz rings and elevator stops at the current floor.
Inspection operation	When elevator enters into inspection state, car runs in jog state.
Troubleshooting	Controller can record faults in memory to facilitate the fault elimination and restore elevator running.
Auto-stop with fault	When there is any fault occurred in elevator running, when safety circuit is valid, elevator lands to the nearest floor.
Repeat open / close door	On normal mode, after running door close command, if door inter-lock circuit isn't connected, elevator opens door and closes it again.
Top/bottom limit and final limit protection	The devices can prevent elevator from crashing to the top or bottom of hoistway in case that elevator is out of control with fault. It ensures the safety and reliability.
Down running protection	When elevator runs down in over speed, this device cuts off the control power to stop the motor running, safety gear is motivated to force elevator to stop and ensure the safety.
Up running protection	When elevator runs up in over speed, the device forces elevator to decelerate and braking.
Safety circuit protection	When elevator circuit is break or contacts are adhered, elevator stops running at once.
Door interlock protection	Only all doors are completely closed, elevator can run. When door interlock contacts are adhered, elevator stops running at once.
Main contactor protection	System detects if the main contactor acts reliably, if any abnormal is deteted, elevator stops running at once.
Brake detecting protection	System detects the brake state, if there is any abnormal or braking contacts are adhered, elevator can't start running.
Micro push button	C.O.P. and H.O.P. both adopts new micro push button.

Standard Function

Running state display	System can indicates running direction, floor, door state, default ect.
No stop floor set	Set the no stop floor according to the customer' requirement.
Homing floor set	Set the homing floor according to the customer' requirement.
Hoistway self-learning	Through hoistway self-learning, system can measure out the distance between every floor and record them permanently.
Emergency lighting	When power is off, car emergency light twin on automatically.
Emergency electric operation	When elevator enters into emergency electric operation state, elevator runs in low speed inching running.
5-way intercom	Communication between car inner, car top, machine room, pit and security room through interoms is realized.
Alarm bell	In emergency situation, pressing the alarm bell button on C.O.P. continuously , alarm bell on car top will ring.
Fan& light automatic off	If there is no car call or landing call in a preset time, car inner fan and light will be turn off automatically.
Protection device for accidental movement of the car	In case of accidental movement that the car leaves the landing floor while the landing door is unlocked as well as the car door keeps open, protection device to prevent or stop such movement should be equipped.

Optional Function

Door close delay	Pushing the door open button in car can prolong the door open state for a period.
Fire emergency return	In fire emergency state, all landing calls are eliminated, elevator runs to the preset floor and open door.
Duplex control function	This function is for two elevators' duplex control, it can reduce waiting time and improve the running efficiency.
Opposite door control	By setting opposite system can control it's action on corresponding floor.
Sub-C.O.P.	It is used for large load elevator, so that make more convenient for passengers
IC card control	All (part) of the floors need entry approval, only with IC card can run the elevator.
Automatic Rescue Device (ADR)	When power is off, this device supplies power to elevator, elevator runs to the nearest floor, open its door and evacuates the passengers.
Traction machine monitor	The monitor for machine room less elevator installed on the traction machine top can monitor the traction machine state.

FUJI Escalator

Designing and Styles Mingled with Modern Atmosphere

FUJI serial escalator products are produced against international standard. It fully applies novel materials and advanced technology on escalator design and manufacture. It has the features such as smooth running, low noise, fine durability, convenient repair, fine and exquisite structure, consummate lift-way, remarkable belt-way, attractive outline model, magnificent design style with gentle flavor, A safe, cozy and beautiful escalator can let you enjoy the pleasant and comfortable moment every day.

FUJI serial escalator get the fine and exquisite design, the unique properties, the sound energy-saving and environmental protection, the extraordinary quality. It serves the passengers by the secure, reliable, simple and prompt transport means. You can be rest assured in using FUJI products. The diversified outlook design remarkably merges itself and the architectures into one integrated mass.

Superior Performance of Escalator

- The truss utilizes first class rectangle steel with unique structure, high strength and nice anti-corruption durable features.
- The overall design is concise and smooth and compatible.
- The advanced international craftsmanship ensures the accuracy of steps.
- The large size diameter of step roller operates minimizes the noise and prolongs the product life.
- The human-oriented handrail entrance is secured by brush.
- The skirt together with interior and outside deck uses dulex stainless steel.
- Stamping stainless steel front panels are available with various varieties.
- It adopts belt braking system controlled by braking motor which brakes smoothly and reliable.
- The super CPU main board monitors the operation in real time. If any abnormal situation occurs, it automatically brakes and records the malfunctions code.
- Customer can choose VVVF drive to control running speed, the energy saving performance is obvious. It can prolong product life and reduce the operation cost.



FUJI Escalator

Moving Walk

FUJI Elevator
富士エレベーター

Superior Performances



1 Compact Structure, Ease Strain

Short pallets can greatly reduce space span, which can flexibly fits the building structure and save the construction space for the customer. It comprises H version (horizontal), I version (incline) and C version (compact) which can let the customer have a free choice on his original layout.

2 Conform to Quality/safety Standard

Slip-free grooves on pallet surface have an excellent slip-proof function which makes the ride save and comfortable. Slightly inclined combs can make trolleys easily get on and off. FUJI Elevator machine with complete protecting function runs smoothly and drives efficiently. Advanced microcomputer controlling system can fully monitor the running status of the moving walk.

3 Stable and Reliable Investment

The pallet directly connecting with the chain which makes the running more smoothly and quietly, thus the service life is extended and its maintenance can be easily conducted. Special designed big wheel handrail drive runs in low noise and big power, which improves the running condition of handrail. Its life is hence prolonged. Unique tube structure has a big load capacity, which greatly improves the overall stability and service life.



4 Colorful Decoration

Various style handrails can meet personal demand in different environments. Beautiful stainless steel floor plate has a three-dimensional effect. Inner and outer decking adopts stainless steel.

5 Incomparable Economical

The moving walk fully utilizes advanced manufacturing process, greatly improves product performance and service life, the most direct result is that the operation cost of the customer is reduced. The optional VF drive technology yields great energy-saving, reducing the running cost to the maximum.



Perfect Model Brings about the Finer Riding Experience

The FUJI moving walk brings a new level of simplicity and comfort to shopping. It allows easy and safe access to all parts of the building, even when moving with a loaded cart or trolley.

Blending engineering knowhow and style, this reliable and durable solution from FUJI, a globally recognized escalator and moving walk specialist, is an asset to any quality shopping experience.

Safety Device

Safety Device of Escalator



Standard Safety Device

1.Lack of phase, error phase protection:

If lack of phase or error phase has been checked out, the escalator (moving-walk) will automatically stop the operation.

2.Motor over-load protection:

When the current exceeds 15% of the current rating, the escalator will automatically stop the operation.

3.Electrical appliance loop protection:

It offers the automatic circuit disconnecting device to protect the circuit and mains components of the escalator (moving-walk).

4.Handrail inlet protection:

When some foreign substance has been clipped in the handrail inlet, the escalator (moving-walk) will automatically stop the operation.

5.Comb plate safety device:

When some foreign substance has been clipped in or between the combs, the escalator (moving-walk) will automatically stop the operation.

6.Step sagging protection device:

When there is abnormal step bending, the escalator (moving-walk) will stop the operation before the step entering into the comb plate.

7.Broken drive-chain safety device:

When the drive-chain has been over-stretched or it is broken, the escalator (moving-walk) will automatically stop the operation.

8.Broken step chain protection:

When the step (plate) chain has been over-stretched or it is broken, the escalator (moving walk) will automatically stop the operation.

9.Over-speed protection:

When there is over-speed to the escalator (moving walk), it will automatically stop the operation.

10.Direction reversal protection:

When it comes the unintentional reversal of the direction of travel, the escalator (moving walk) will automatically stop the operation.

11.Security line:

The yellow synthetic resin security line is located in the front position and two sides of the escalator tread so that the passengers will not tread in-between the edge of the adjacent step and the lift group lengthened skirt panel. The security line on both sides of the step is higher than the tread surface. (The moving-walk offers the selective yellow spray-painted security line.)

12.Emergency stop button:

When the button has been pressed down, the escalator (moving-walk) will stop the operation.

Safety Device of Moving Walk

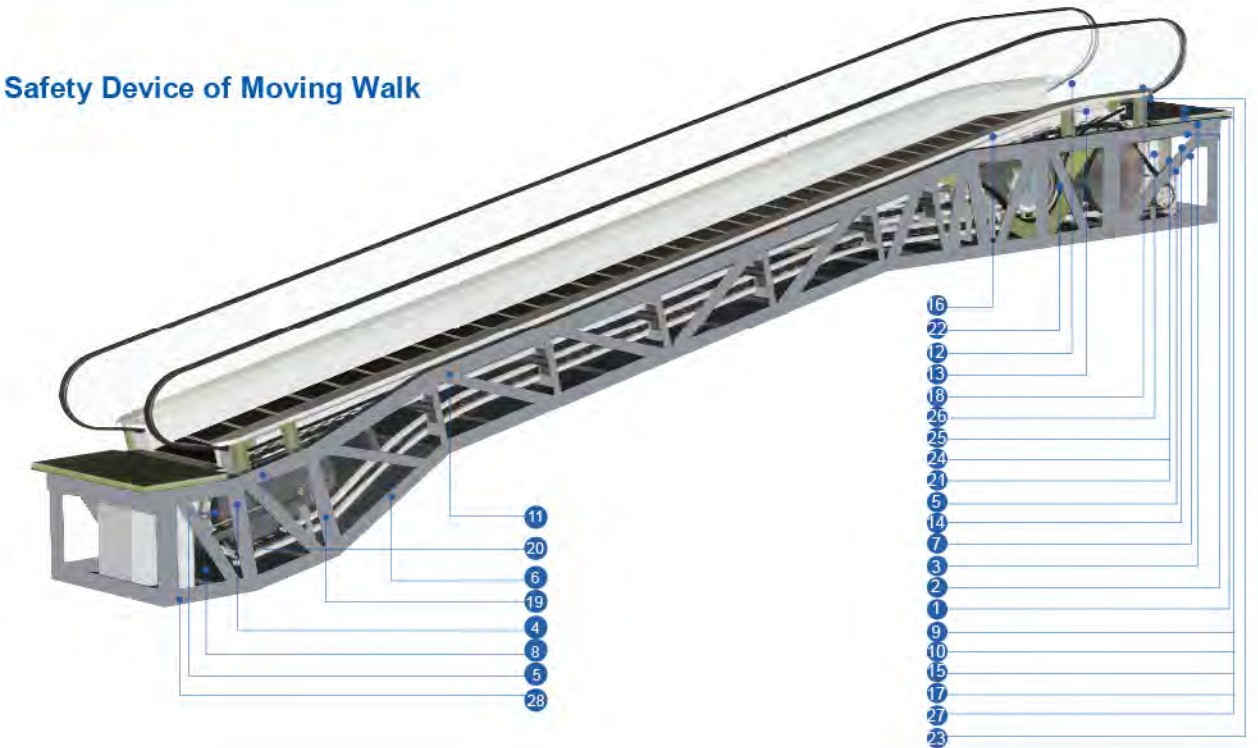

13.Skirt panel protection:

When some foreign substance has been clipped in between the skirt panel and the step, the escalator (moving-walk) will automatically stop the operation.

14.Brake protection:

When the electric force falls short of supply or it acts any of the safety device, the brake function goes into effect by the safety device through the spring resilience action. In this way, the escalator (moving-walk) stop the operation.

15.Safety inspection switch:

It is a safety device to prevent from the escalator starting during the inspection and maintenance.

16.Step illumination:

Illumination exists in the upper and lower ends of the escalator, in the lower part of the step in order to remind the passengers of the security matters.

17.Alarm bell starting device:

The alarm bell rings when it starts the escalator in order to remind the passengers of the security matters.

18.Control device for handrail breakage:

When the handrail is broken, the escalator will automatically stop the operation.

19.Handrail speed monitor:

When the handrail speed versus step is slower than certain percentage, the escalator (moving-walk) will stop the operation.

20.Skirt panel brush:

It is a selective safety device. The brush that has been installed between the skirt panel and the step will prevent the passengers from touching the skirt panel. (It is not merely restricted to the escalator.)

21.Double independent control systems:

It brings about the safer and the more stable escalator travel.

22.Step loss detection device:

Safety device to protect the passengers.

23.Tread swart switch:

When it opens the tread and maintains the escalator, the escalator stops and is under security condition.

24.Detection of brake distance:

If braking distance is 1.2 times longer than stipulation of national standard, after trouble locking and reset, it starts again. If necessary, please check braking system before manual reset and apply correction measures.

25.Brake release detection:

Brake adding detection switch prevents from the motor running without brake release so that it avoids burning the host or fire disaster.

Optional Safety Device

26.Emergency brake:

It prevents from the escalator slide and ensures the human security in case of the drive chain breakage or the out-of-order of the brake. (It shall be allocated when 6m < H. It is standard configuration of moving walk.)

27.Fire-proof rolling door device:

When this device comes into action, it can stop the escalator (moving-walk) operation. It has been installed near the escalator (moving-walk).

28.Lower machine room drain:

When it exceeds the standard to water intake in the lower machine room, it will operate the automatic drain system. (outdoor type)

Standard Functions

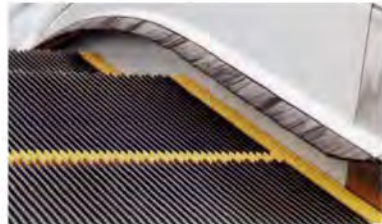

Skirt Panel Brush

The skirt board brushes, mounted on both sides of the skirt boards and located above the steps, can not only avoid the passengers' shoes to collide on the skirt boards but also effectively avoid the entry of foreign objects into the steps.



Handrail Inlet

The escalator is richly endowed with the intelligence and popularity by the novel, distinctive, elegant, tensile and modernized streamline handrail inlet and outlet design model. It appears to be more beautiful in the outer appearance. It displays the nobleness and imposing manner of the conveying constructions.



Automatic Oiling

PLC control automatic oiling and lubricating system fulfills the ideal automatic lubrication to the transmission chain during the running process of the escalator. It not only reduces the daily repair and maintenance word load, but also prolongs the service life of the driving mechanism.

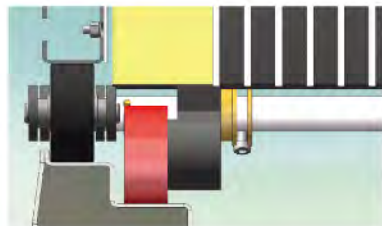

Side Guide High Accuracy Step Guide Rail System

High rigidity big profile guide rail with nose used as transverse step positioning, guarantee the minimum gap between the skirt and step, decrease the possibility of objects clamp in between.



Driver Protection Strand Breaks

When the drive chain excessive tensile fracture, the escalator stops automatically to protect the safety.



Outstanding Technology

Ecological Design for Efficiency

- Energy efficient and user-friendly stand-by speed to enhance energy effectiveness.
- Automatic start/stop.
- Absolute ecological and fire safety. With lubrication free chain.
- Advanced components to give a lifetime of reliable performance.
- FUJI expertise and know how in maintenance and service.

Fault Display

When some defect takes place, the trouble code will be displayed in the defect screen. It ensures the effective and accurate trouble position within the shortest time possible. In this way, it greatly enhances the repair and maintenance efficiency.



Fault Display

Handrail Speed

When handrail running speed and running speed ratio exceeds cascade system settings, escalators stopped running.



Handrail Speed



Handrail Color
Black(standard)



The Glass Wainscot Color
Colorless and transparent (standard)

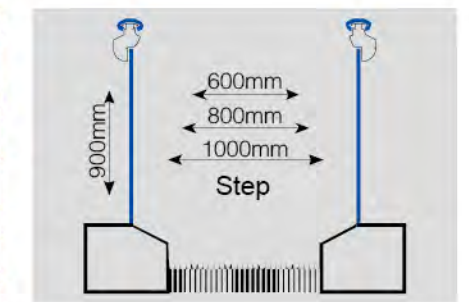

Balustrade Height
(1000mm is standard specification)



Optional Function

Outstanding Technology

Energy Saving Operation Modes

It can adopt variable frequency control or the automatic starting mode to fulfill the energy-saving.

Standard Offering Has High End Finishes

- Eye-catching yellow plastic comb makes the ride of escalator more safe and more easy.
- 3mm thick skirt panel decreases the distortion and anti-friction material ensures less friction between skirting and step.

Illumination for the Passengers

Green light softly beams out from the space between the engaged teeth of the two neighboring steps to remind the passengers to be aware of the level sections both at the entrance and exit, resulting in increased security for the passengers.

Skirt-board Lighting

Two sides LED lighting lamp, with the clear effect on the evening of step running.



Capacity

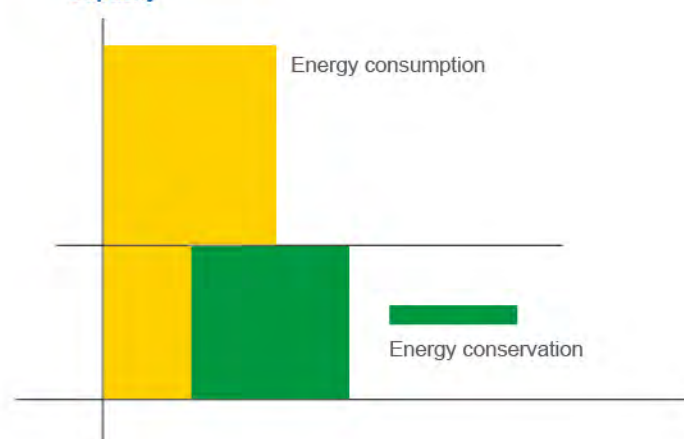

Comb lighting

Lighting was installed near the apron panel beside the comb plate, to provide lighting for the steps and the comb plate to facilitate passengers safe ride.

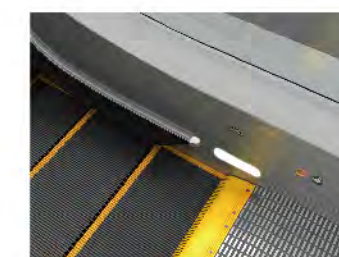

Running Direction Indication

The running direction and forbidden display mark have been placed in the inlet and outlet of the handrail. The obvious running or forbidden instruction ensures the safe riding of the passengers with great ease.



Heating Device

Each escalator usually installs three heating devices. One is beside the host in the upper machine room. It mainly heats the host. The second is installed in the mid escalator. And the third is in the lower part. It mainly heats the whole escalator.



Voice HMI System

When installed in the entrance for passengers, the voice prompts to take precautions.



Handrail Color (Optional)



Strategic Planning



Feasible Design Plan

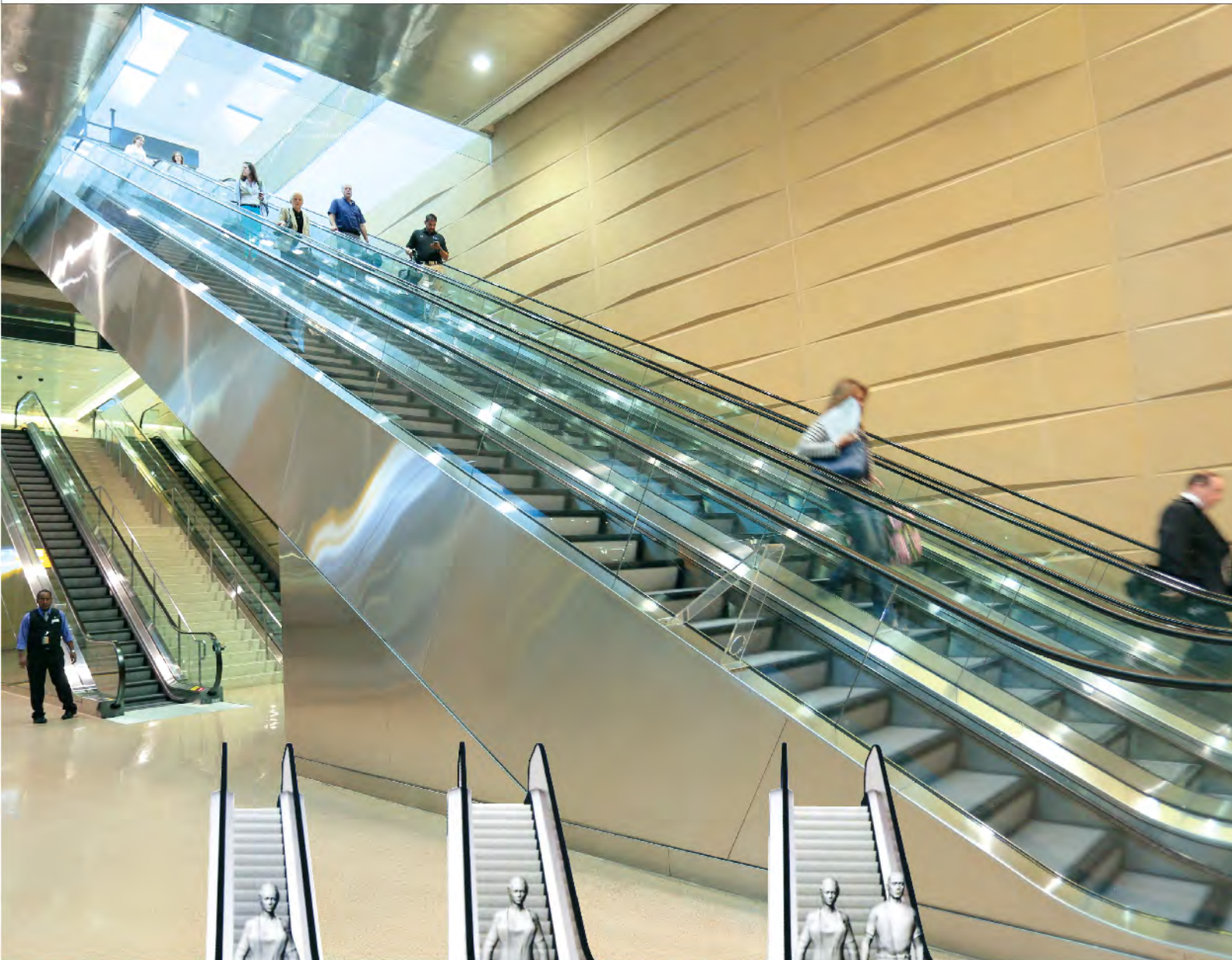

Step width 600mm

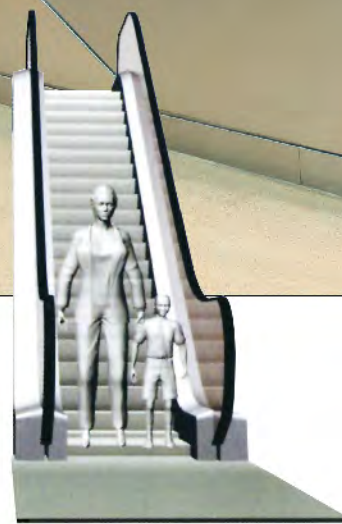

Step width 800mm



Step width 1000mm

Single unit

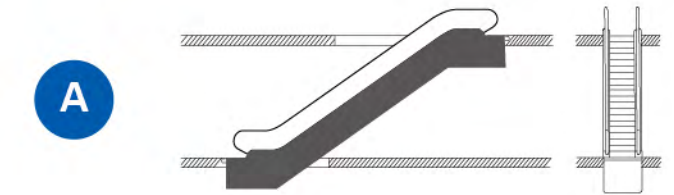

Continuous arrangement
(one-way traffic)

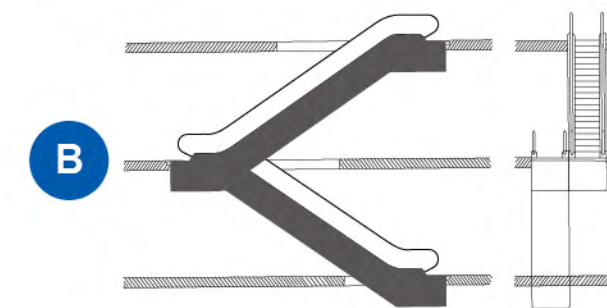

Interrupted arrangement
(one-way traffic)

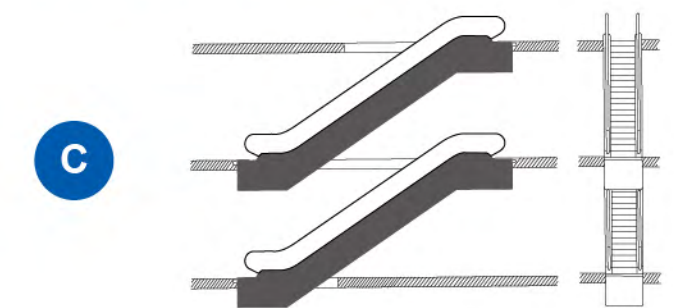

Crisscross, continuous arrangement
(two-way traffic)

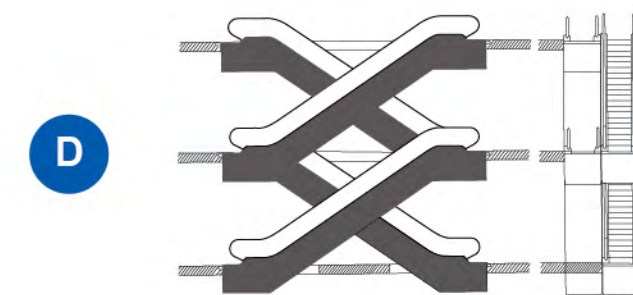

Parallel, interrupted arrangement
(two-way traffic)

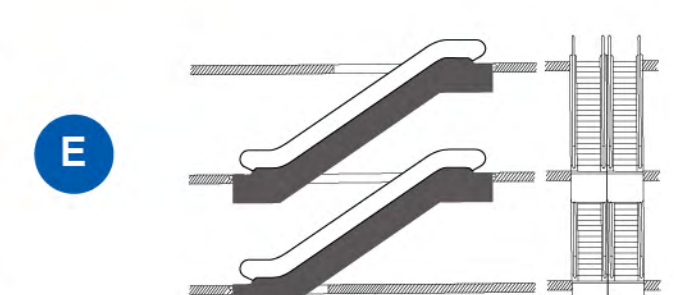

Small Machine Room Elevator Construction Layout Drawing

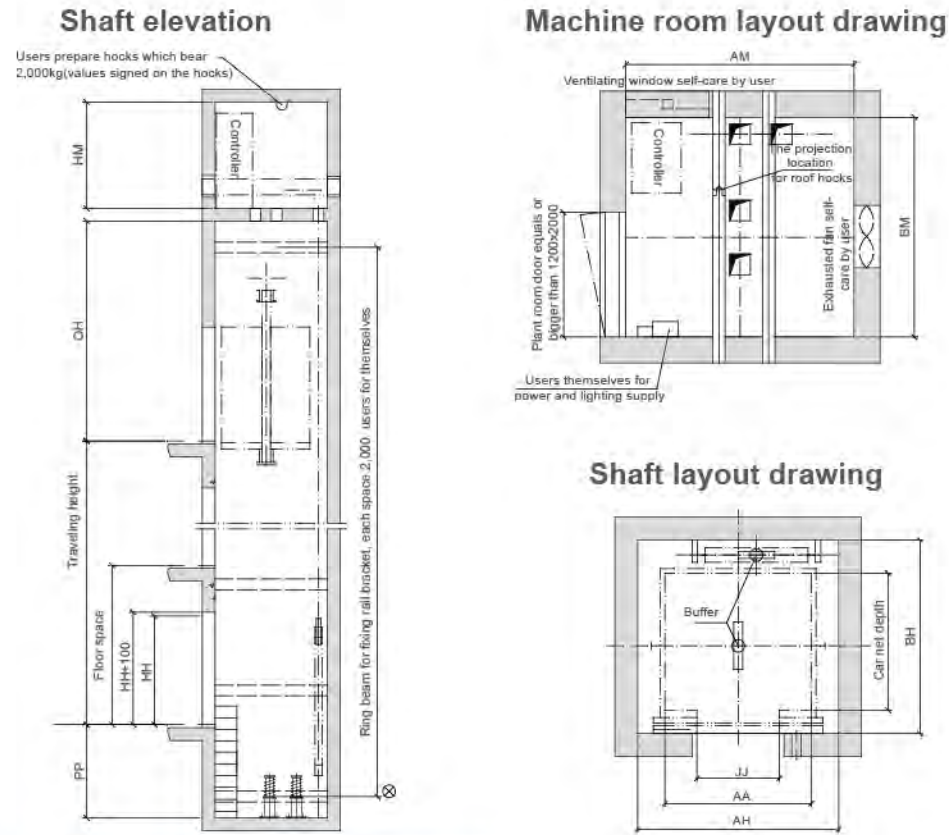

Small Machine Room Elevator Specifications

Persons	Rated capacity (kg)	Rated speed (m/s)	Net size of car (mm)		Shaft size (mm)			Machine room size (mm)	
			C.W x C.D x D.H	2P Central opening	H.W x H.D	HR.H	PIT	MR.W x MR.D	MR.H
6	450	1.0	1400x850x2300	800x2100	2000x1500	4000	1500	2000x1500	2500
		1.5/1.75				4400			
8	630	1.0	1400x1100x2300	800x2100	2000x1720	4200	1500	2000x1720	2500
		1.5/1.75				4400			
10	800	1.0	1400x1350x2300	800x2100	2000x1970	4200	1500	2000x1970	2500
		1.5/1.75				4400			
		2.0				4800			
		2.5				5200			
		3.0				5500			
		3.5				6000			
13	1000	1.0	1600x1450x2300	900x2100	2200x2120	4200	1500	2200x2120	2500
		1.5/1.75				4400			
		2.0				4800			
		2.5				5200			
		3.0				5500			
		3.5				6000			
16	1250	1.0	1900x1450x2300	1100x2100	2500x2150	4200	1500	2500x2150	2500
		1.5/1.75				4400			
		2.0				4800			
		2.5				5200			
		3.0				5500			
		3.5				6000			
18	1350	1.0	1900x1550x2300	1100x2100	2500x2250	4200	1500	2500x2250	2500
		1.5/1.75				4400			
		2.0				4800			
		2.5				5200			
		3.0				5500			
		3.5				6000			
21	1600	1.0	1900x1800x2300	1100x2100	2500x2500	4200	1500	2500x2500	2500
		1.5/1.75				4400			
		2.0				4800			
		2.5				5200			
		3.0				5500			
		3.5				6000			
25	2000	1.0	1900x2200x2300	1100x2100	2700x2700	4200	1500	2700x2700	2500
		1.5/1.75				4500			
		2.0				4800			
		2.5				5200			
26	2000	1.0	1900x2200x2800	1100x2100	2700x3350	4200	1500	4200x3350	3800
		1.5/1.75				4500			
		2.0				4800			
		2.5				5200			

Note: Only for reference, final manufacture please follow contract.

Machine Roomless Elevator Construction Layout Drawing

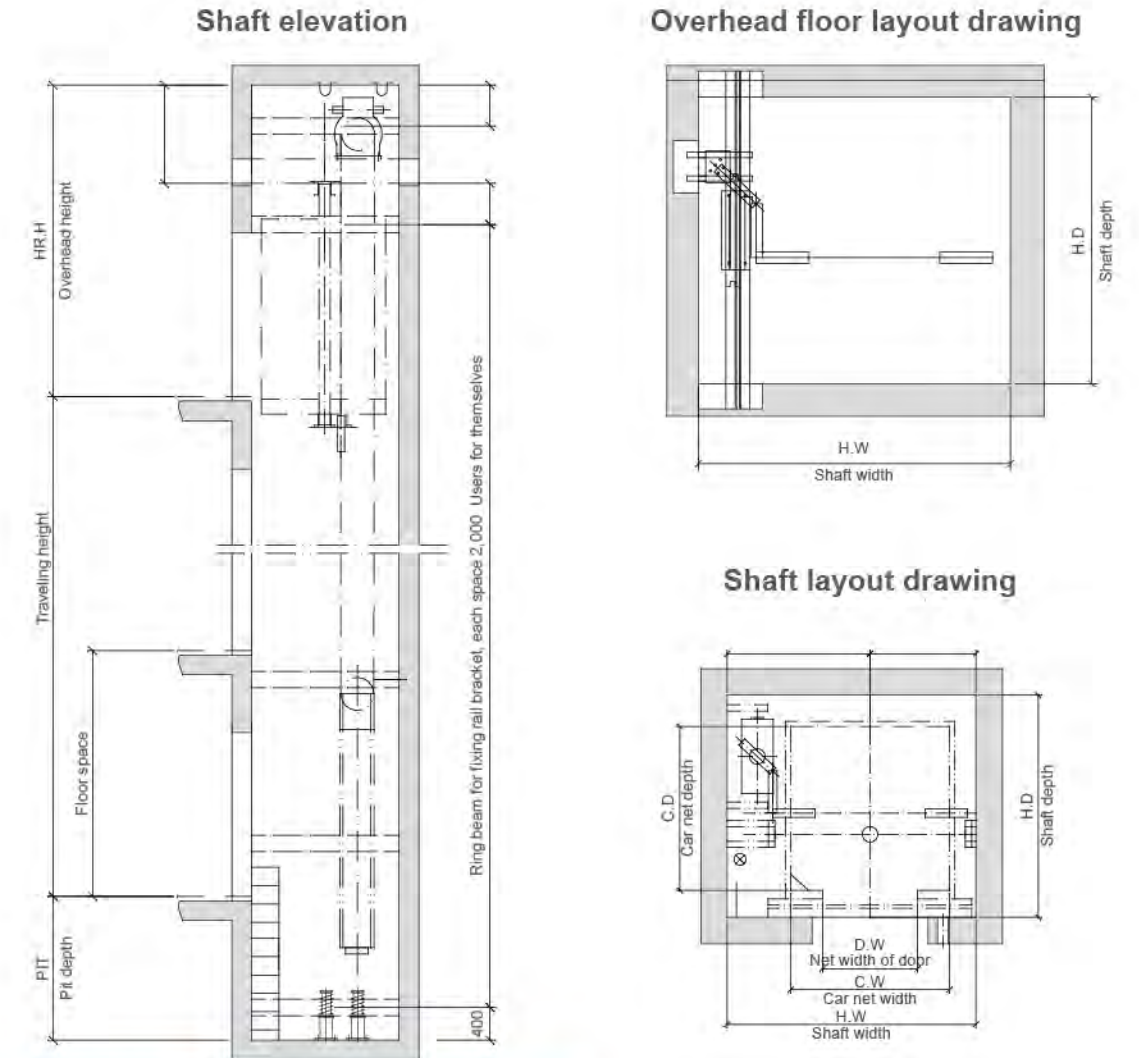

Machine Roomless Elevator Specifications

Persons	Rated capacity (kg)	Rated speed (m/s)	Net size of car (mm)		Shaft size (mm)		
			C.W x C.D x D.H	2P Central opening	H.W x H.D	HR.H	Pit
6	450	1.0	1100x1100x2300	800x2100	2050x1850	4200	1500
8	630	1.0				1400x1100x2300	800x2100
		1.5/1.75	4400	1600			
10	800	1.0	1400x1350x2300	800x2100	2250x1950	4200	1500
		1.5/1.75				4800	1800
		2.0					2000
13	1000	1.0	1500x1550x2300	900x2100	2350x2150	4200	1500
		1.5/1.75				4400	1600
		2.0					1800
21	1600	1.0	1900x1800x2300	1100x2100	2850x2400	4500	1500
		1.5/1.75				4700	1600
		2.0					1800
26	2000	1.0	1900x2200x2300	1100x2100	2900x2600	4500	1500
		1.5/1.75				4700	1600
		2.0					1800
		2.5					2000

Note: Only for reference, final manufacture please follow contract.

Bed Elevator Construction Layout Drawing

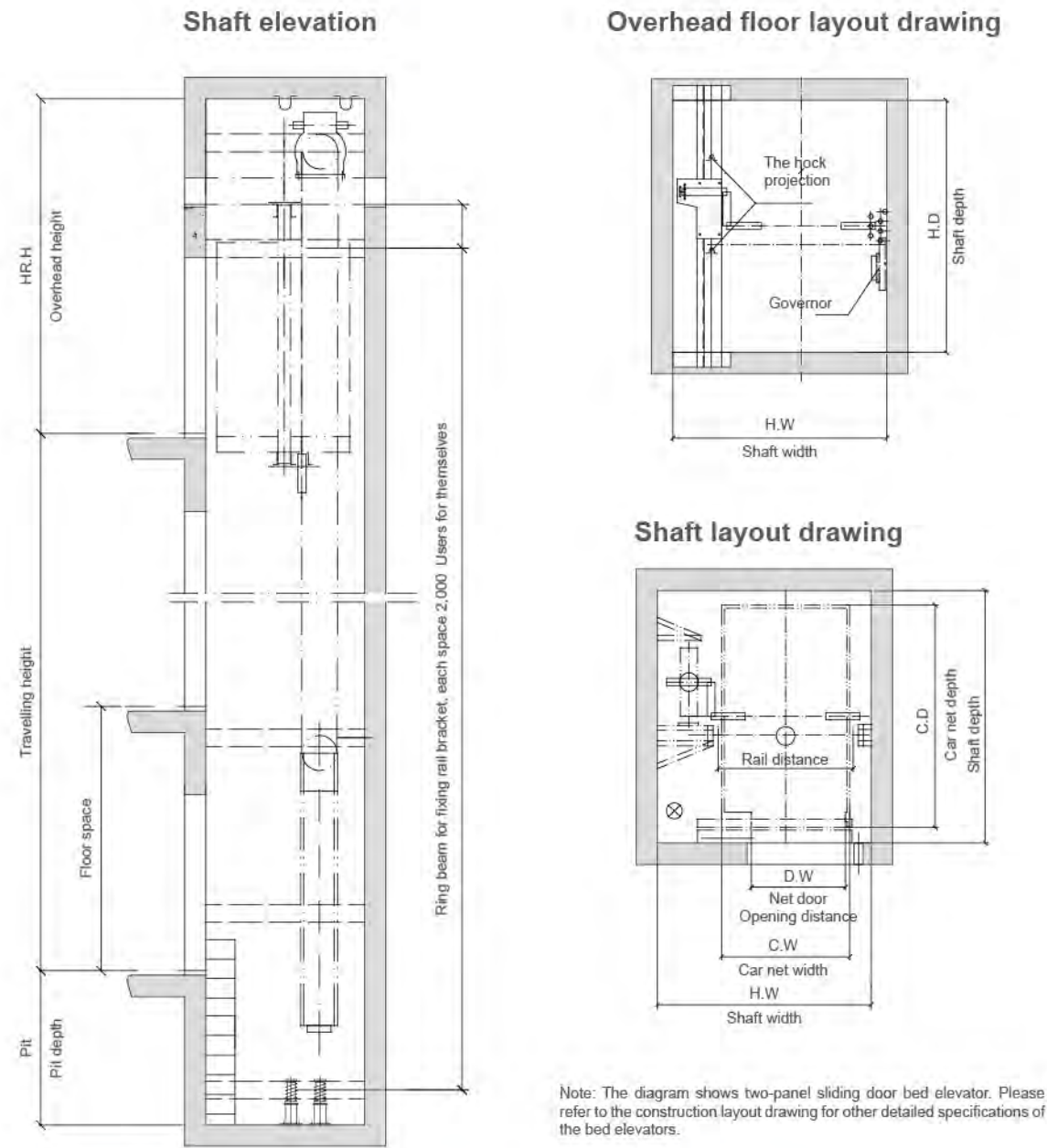

Machine Room/ Machine Roomless Bed Elevator Specifications

Persons	Rated capacity (kg)	Rated speed (m/s)	Net size of car (mm)		Shaft size (mm)			Machine room size (mm)	
			C.W x C.D x D.H	D.W x D.H	H.W x H.D	HR.H	Pit	MR.W x MR.D	MR.H
21	1600	1.0	1400x2400x2300	1100x2100	2550x2900	4500	1500	2550x2900	2500
		1.5/1.75				4700	1600		
		2.0				4900	1800		
		2.5				5100	2000		
24	1800	1.0	1600x2400x2300	1200x2100	2750x2900	4500	1500	2750x2900	2500
		1.5/1.75				4700	1600		
		2.0				4900	1800		
		2.5				5100	2000		
26	2000	1.0	1700x2400x2300	1200x2100	2850x2900	4500	1500	2850x2900	2500
		1.5/1.75				4700	1600		
		2.0				4900	1800		
		2.5				5100	2000		

Note: Only for reference, final manufacture please follow contract.

Villa Elevator Construction Layout Drawing

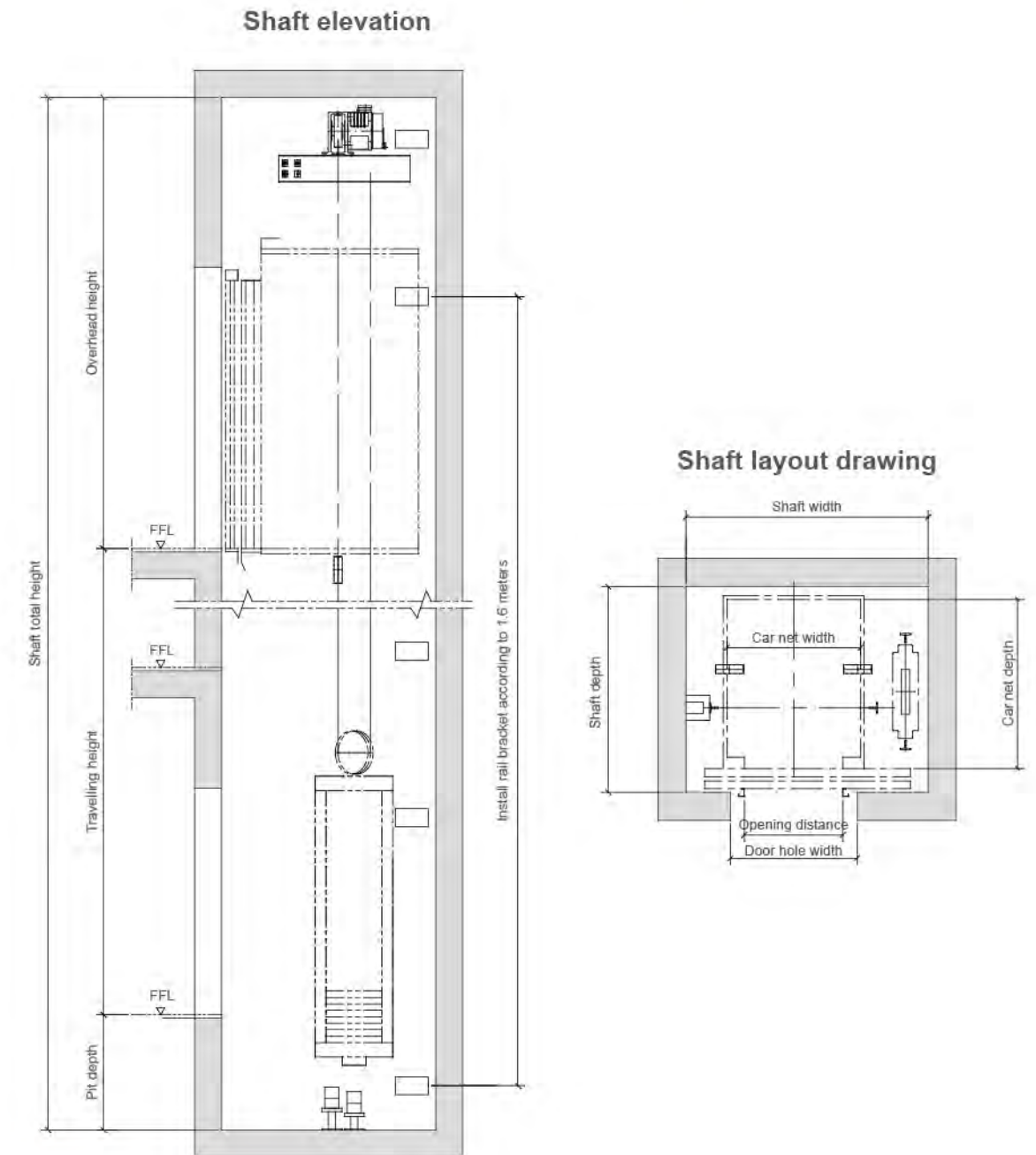

Villa Elevator Specifications

Persons	Rated capacity (kg)	Rated speed (m/s)	Net size of car (mm) C.W x C.D x D.H	Net size of door (mm) D.W x D.H 2P Central opening	Shaft size (mm)		
					H.W x H.D	HR.H (mm)	PIT (mm)
3	260	0.4	800x1150x2200	700x2000 (Side opening)	1400x1500	3500	800
4	320	0.4	950x1300x2200	700x2000	1600x1600	3500	800
5	400	0.4	1200x1300x2200	800x2000	1850x1600	3500	800

Note: Only for reference, final manufacture please follow contract.

Semicircle Panoramic Elevator Construction Layout Drawing

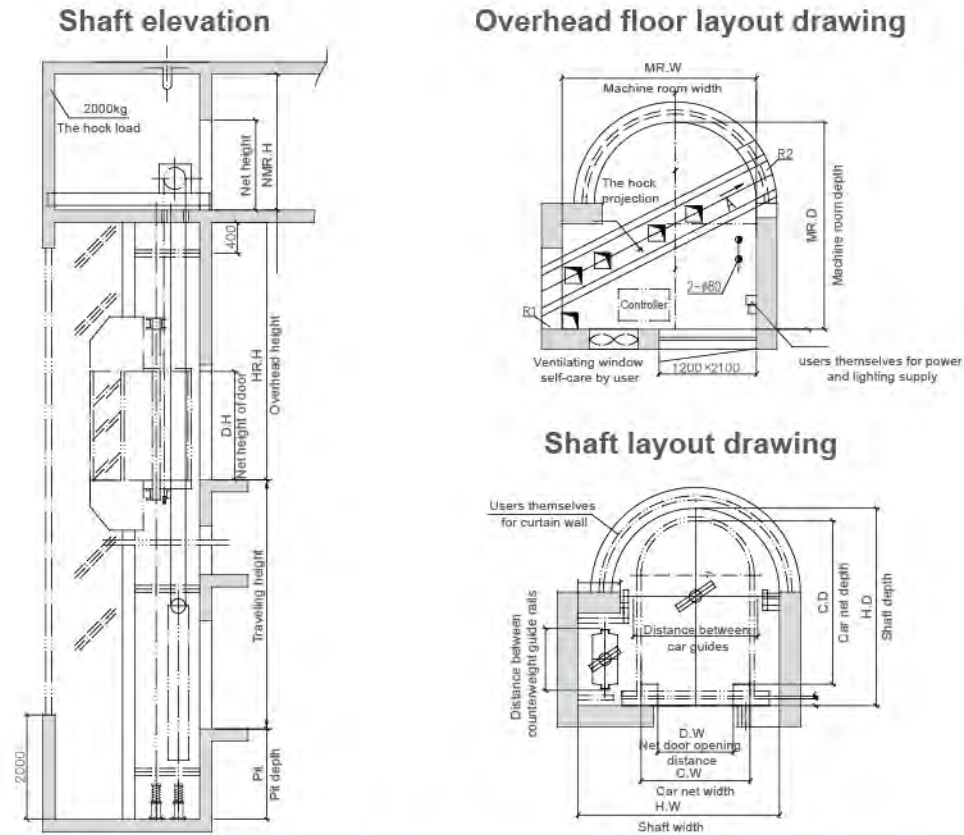

Square Panoramic Elevator Construction Layout Drawing

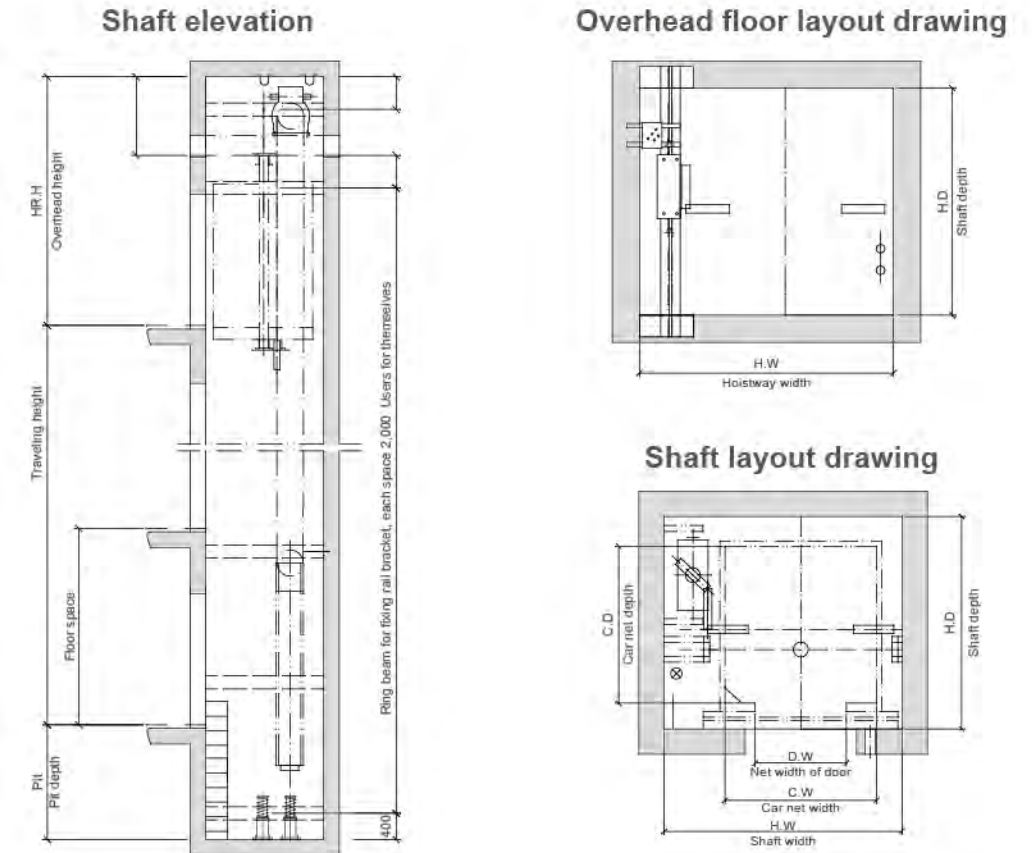

Semicircle Machine Room or Machine Roomless Elevator Specifications

Persons	Rated capacity (kg)	Rated speed (m/s)	Net size of car (mm) C.W x C.D x D.H	Net size of door (mm) D.W x D.H	Shaft size (mm)			Machine room size (mm)	
					H.W x H.D	HR.H	Pit	MR.W x MR.D	MR.H
8	630	1.0	1100x1600x2300	700x2100	2200x2185	4500	1500	2200x2185	2500
		1.5/1.75				4700	1600		
10	800	1.0	1200x1800x2300	800x2100	2300x2355	4500	1500	2300x2355	2500
		1.5/1.75				4700	1600		
		2.0				4900	1800		
		2.5				5100	2000		
13	1000	1.0	1300x1950x2300	900x2100	2400x2535	4500	1500	2400x2535	2500
		1.5/1.75				4700	1600		
		2.0				4900	1800		
		2.5				5100	2000		
16	1250	1.0	1400x2150x2300	900x2100	2500x2600	4500	1500	2500x2600	2500
		1.5/1.75				4700	1600		
		2.0				4900	1800		
		2.5				5100	2000		
18	1350	1.0	1500x2150x2300	1000x2100	2600x2600	4500	1500	2600x2600	2500
		1.5/1.75				4700	1600		
		2.0				4900	1800		
		2.5				5100	2000		
21	1600	1.0	1500x2450x2300	1100x2100	2600x2900	4500	1500	2600x2900	2500
		1.5/1.75				4700	1600		
		2.0				4900	1800		
		2.5				5100	2000		
		3.0				5200	2600		
		4.0				6000	3850		
26	2000	1.0	1700x2600x2300	1100x2100	2800x3050	4500	1500	2800x3050	2500
		1.5/1.75				4700	1600		
		2.0				4900	1800		
		3.0				5200	2600		
		4.0				6000	3850		

Note: Only for reference, final manufacture please follow contract.

Square Machine Room, Machine Roomless Panoramic Elevator Specifications

Persons	Rated capacity (kg)	Rated speed (m/s)	Net size of car (mm) C.W x C.D x D.H	Net size of door (mm) D.W x D.H	Shaft size (mm)		
					H.W x H.D	HR.H	Pit
6	450	1.0	1100x1100x2300	800x2100	2050x1850	4200	1500
8	630	1.0	1400x1100x2300	800x2100	2250x1900	4200	1500
		1.5/1.75				4400	1600
10	800	1.0	1400x1350x2300	800x2100	2250x1950	4200	1500
		1.5/1.75				4400	1600
		2.0				4800	1800
		2.5				4800	2000
13	1000	1.0	1500x1550x2300	900x2100	2350x2150	4200	1500
		1.5/1.75				4400	1600
		2.0				4800	1800
		2.5				4800	2000
21	1600	1.0	1900x1800x2300	1100x2100	2850x2400	4500	1500
		1.5/1.75				4700	1600
		2.0				4900	1800
		2.5				5100	2000
		3.0				5200	2600
		4.0				6000	4900
26	2000	1.0	1900x2200x2300	1100x2100	2900x2600	4500	1500
		1.5/1.75				4700	1600
		2.0				4900	1800
		3.0				5200	2600
		4.0				6000	4900

Note: Only for reference, final manufacture please follow contract.

Freight Elevator Construction Layout Drawing

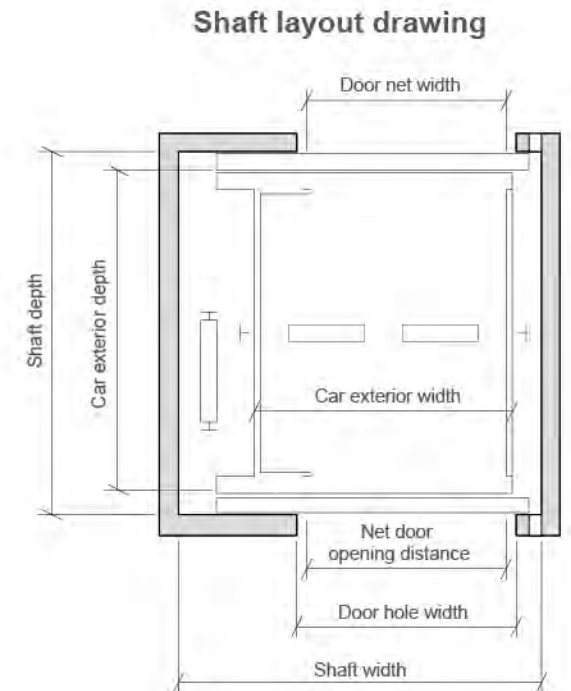
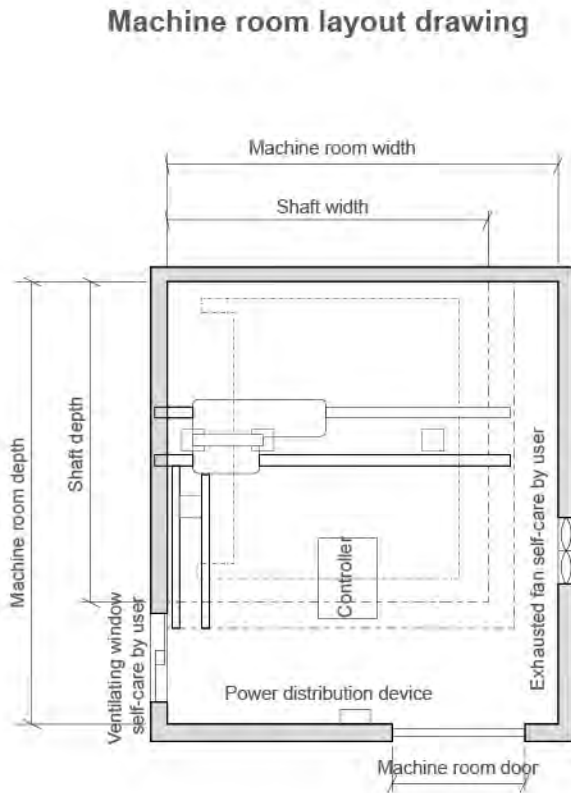
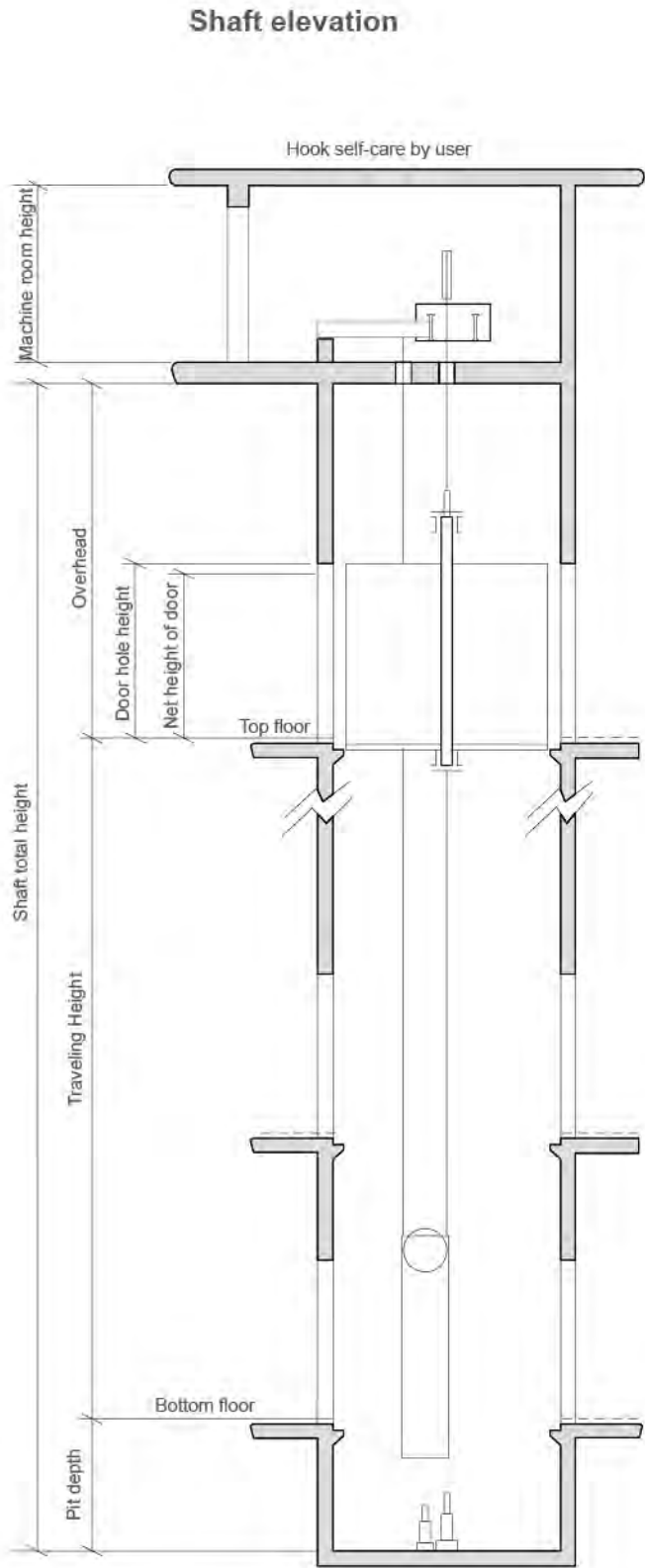

The work owner and civil construction contractor should do:

- 1. All the constructions in the shaft should be fireproofing. Extra holes such as equipments and power which have nothing to do with elevator are forbidden.
- 2. Shaft should be vertical and the horizontal size should be the minimum clearance size. The vertical error should more than.....
- 3. If the space below the bottom of pit can be reached, counterweight buffer should be fixed in the firm center of pit, or please ask the elevator manufacturer for the installation of counterweight safety gear.
- 4. Before the installation, all the landing door halls should have at least 1.2 meter safe guard fence. And the strength should be confirmed.
- 5. Enclosed shaft should set airventilators according to the requests (generally in the top and bottom of the shaft). The size should not less than 1% of horizontal area of the shaft. And protective nets are needed.
- 6. After the finish of installation, elevator hall doors, hall indicators reserved holes and other reserved holes should be filled.
- 7. Shaft preferably is reinforce concrete construction. If the shaft is frame construction, we should install reinforce concrete beam 300mm tall and as wide as shaft at guide rail bracket. If the construction is solid load bearing brick wall, we need to install the same beam on the top and bottom of hall doors reserved holes.
- 8. When the distance between two neighbouring door sills surpass 11 meters, we need to set a safety door opened to maintainers only. The size should not less than 350mm width and 1800mm height.
- 9. Pit should be waterproof. If splash is needed, set it in the corner.
- 10. According to the requests of technical parameter, to pull power supply into machine room, install protective switch and lock. The wave range should not surpass $\pm 7\%$. Zero line and earthing cable should be separated. And ground impedance value should no more than 4.
- 11. The temperature in machine room should keep to 5~40 degree. Machine room should be plate and can bear at least 7.0KN/sq.m. When the floor in machine room is uneven and the discrepancy is more than 500mm, stair or footstep with guard-rail is needed.
- 12. User should set rescue dutyroom and lay one six wicks wire for every machine room (we recommend). The wick should be 0.75 square millimeter at least.

Freight elevator specifications

Load kg	Speed m/s	Exterior size of car width x depth x height (AAxBB)	Net door opening width x height (JJ×HH)	Shaft Net Size (A1×B1)			Machine Room Net Size width x depth x height	Door Open Type
				width x depth	OH	PIT		
630	0.5	1200×1500×2200	1100×2100	2100×1860	4200	1500	2500×3000×2200	Two panel side opening
1000	0.5	1500×1800×2200	1200×2100	2250×2160	4200	1500	3000×3000×2200	Two panel side opening
2000	0.5	1570×2900×2200	1500×2100	2700×3260	4200	1500	3500×3000×2500	Two panel side opening
	1.0				4500	1500		
	1.5	2000×2300×2200	2850×2660	4500	1600	Four panel center opening		
	2.0			4800	1800			
4.0			6000	3850				
3000	0.25	2070×3050×2200	1800×2100	3300×3410	4500	1500	3800×4200×2500	Four panel center opening
0.5								
3200	1.0	2070×3100×2200	2000×2100	3500×3460	4500	1500	3800×4200×2500	Four panel center opening
5000	0.25	2800×3400×2500	2400×2400	4200×3800	5000	1600	4200×3800×2800	Four panel center opening
	0.5							
	1.0							
7000	0.25	3000×4200×2500	2600×2400	4500×4600	5000	1600	4500×4600×2800	Four panel center opening
	0.5							
10000	0.25	3070×5760×2500	2600×2400	4900×6200	5000	1600	4900×6200×2800	Four panel center opening
	0.5							

Note: Only for reference, final manufacture please follow contract.

Machine Roomless (MRL) Freight Elevator Construction Layout Drawing

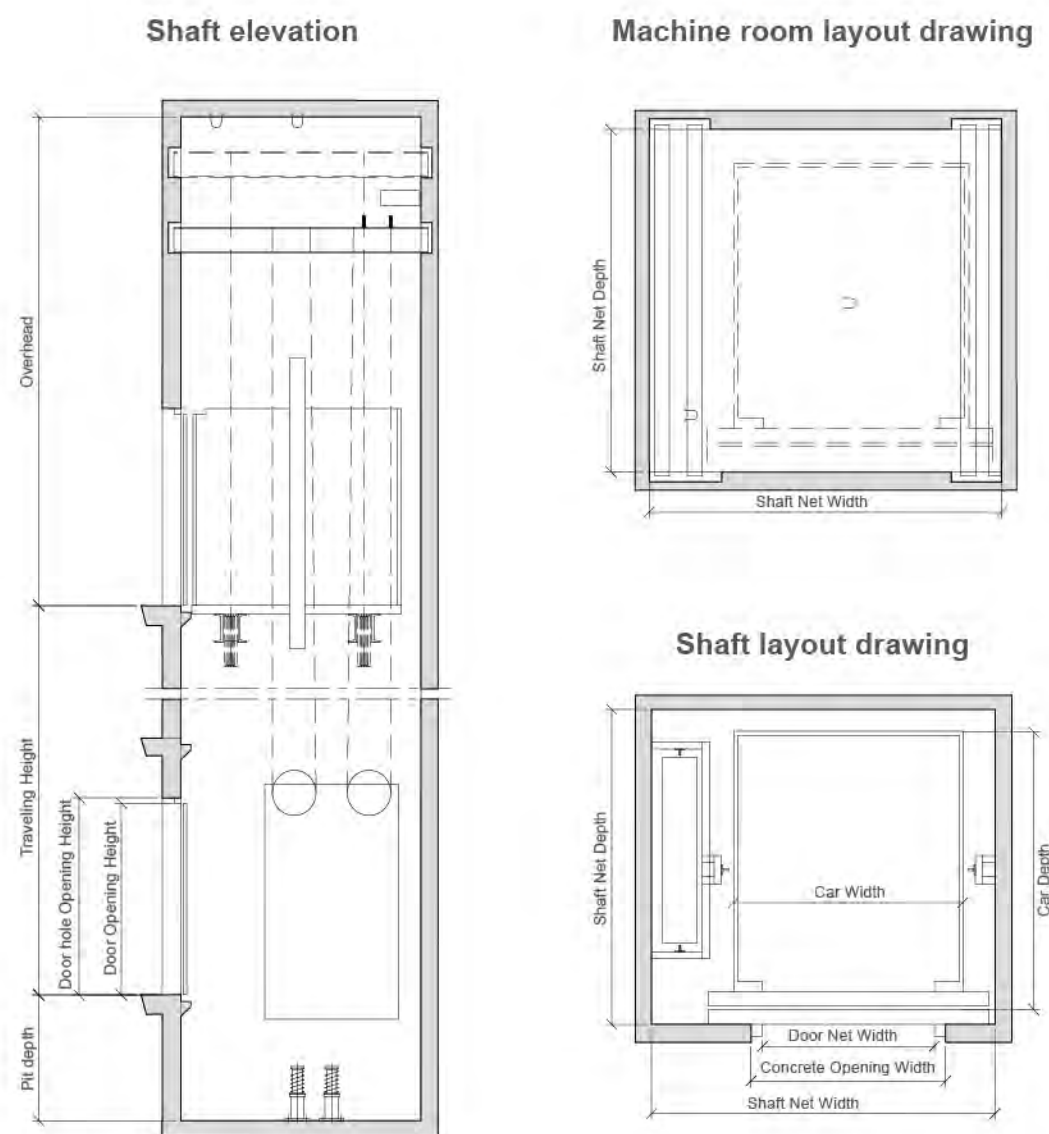

Machine Roomless (MRL) Freight Elevator Specifications

Load kg	Speed m/s	Exterior size of car width x depth x height (mm)	Net door opening width x height (mm)	Shaft Net Size (mm)			Door Open Type
				width x depth (mm)	OH	PIT	
1000	0.5	1500×1800×2200	1200×2100	2250×2200	4500	1500	Two panel side opening
	1.0				4500	1500	
	1.5				4600	1600	
	2.0				4800	1800	
2000	0.5	2000×2300×2200	1500×2100	3150×2660	4800	1500	Two panel side opening
	1.0				5000	1500	
	1.5				5200	1600	
	2.0				5200	1800	
3000	0.5	2470×2560×2200	1800×2100	3700×3000	5000	1600	Four panel center opening
5000	0.5	2800×3400×2500	2400×2400	4250×3800	6100	1600	Four panel center opening

Note: Only for reference, final manufacture please follow contract.

Car Elevator Construction Layout Drawing

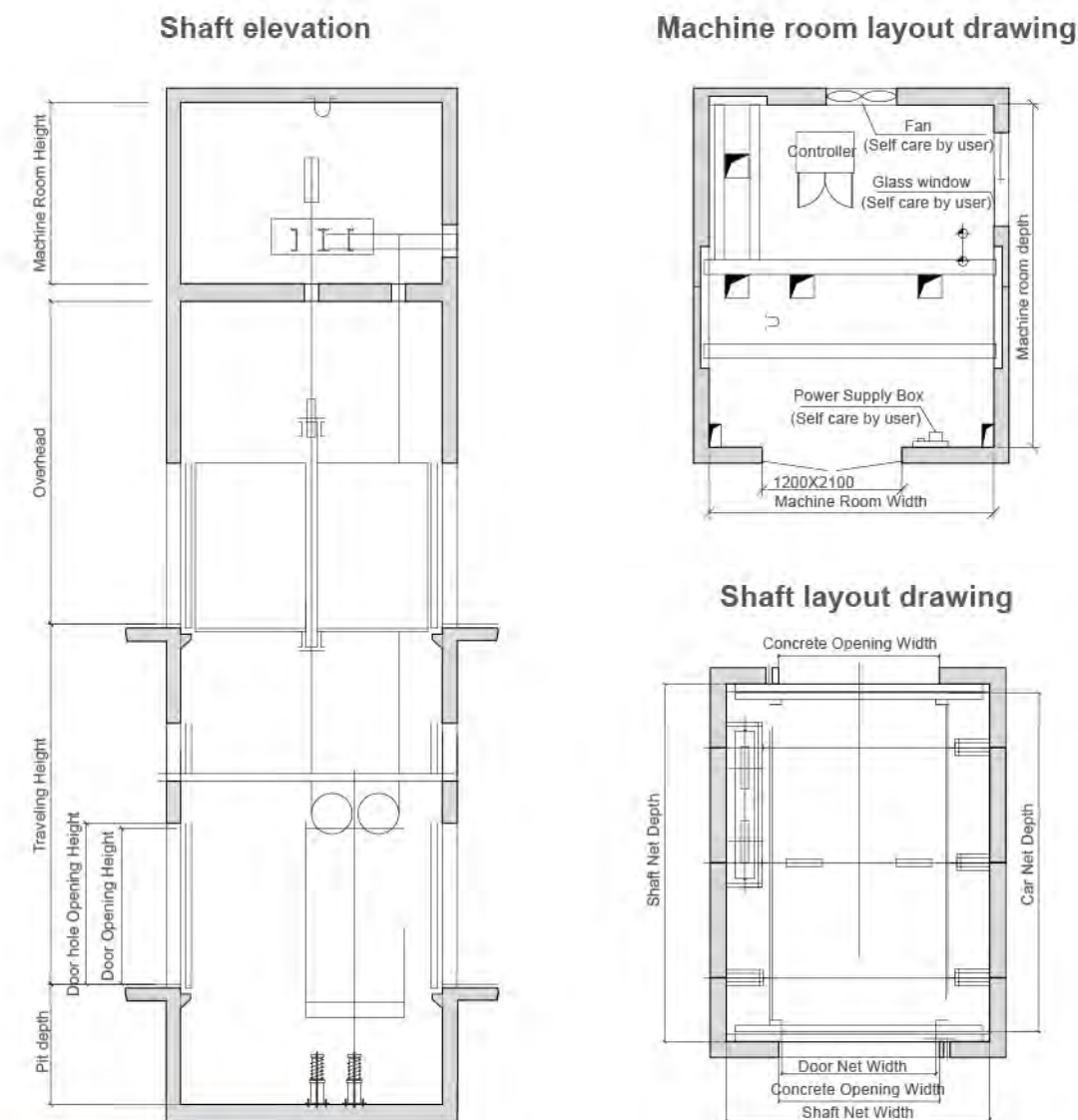

Car elevator specifications

Load kg	Speed m/s	Door open type	Net door opening width x height mm	Exterior size of car width x depth (mm)	Shaft Net Size (mm)			Machine Room Net Size (mm) width x depth x height (mm)
					width x depth (mm)	PIT	OH	
3000	0.25/0.5	Four Panel Center Opening	2400×2200	2700×5800	4100×6160	1600	4800	4100×6160×2500
5000	0.25/0.5	Four Panel Center Opening	2600×2200	3500×7200	4750×7560			

Machine roomless car elevator specifications

Load kg	Speed m/s	Door open type	Net door opening width x height mm	Exterior size of car width x depth (mm)	Shaft Net Size (mm)		
					width x depth (mm)	PIT	OH
3000	0.25/0.5	Four Panel Center Opening	2400×2200	2700×5800	4300×6160	1800	5500
5000	0.25/0.5		2600×2200	3500×7200	4900×7500		

Note: Only for reference, final manufacture please follow contract.

Hydraulic Elevator Construction Layout Drawing

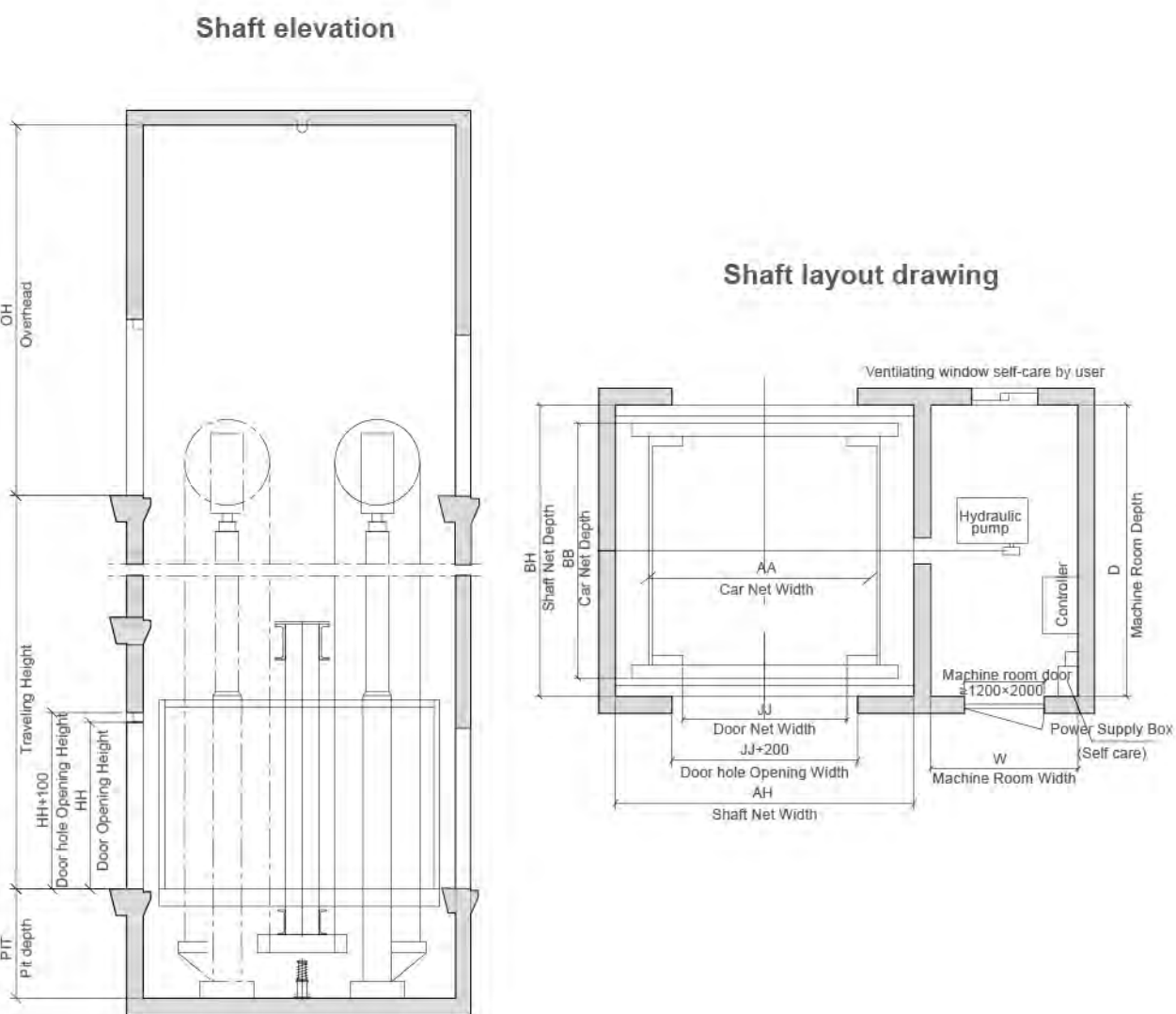

Hydraulic Elevator Specifications

Load kg	Speed m/s	Door Open type	Net door opening JJ×HH (mm)	Exterior size of car AA×BB (mm)	Shaft Net Size (mm)			Machine Room Net Size (mm)
					AH×BH	PIT	OH	
1000	0.25/0.5	Two Panel Side Opening	1200×2100	1500×1800	2400×2160	1500	4200	2000×2160×2200
2000		Two Panel Side Opening	1500×2100	2000×2300	3000×2660			2000×2660
3000		Four Panel Center Opening	1800×2100	2100×3050	3400×3400	1500	4500	2200×3400
5000		Four Panel Center Opening	2400×2200	2800×3400	4200×3800			2500×3500

Note: Only for reference, final manufacture please follow contract.

Dumbwaiter Elevator Construction Layout Drawing

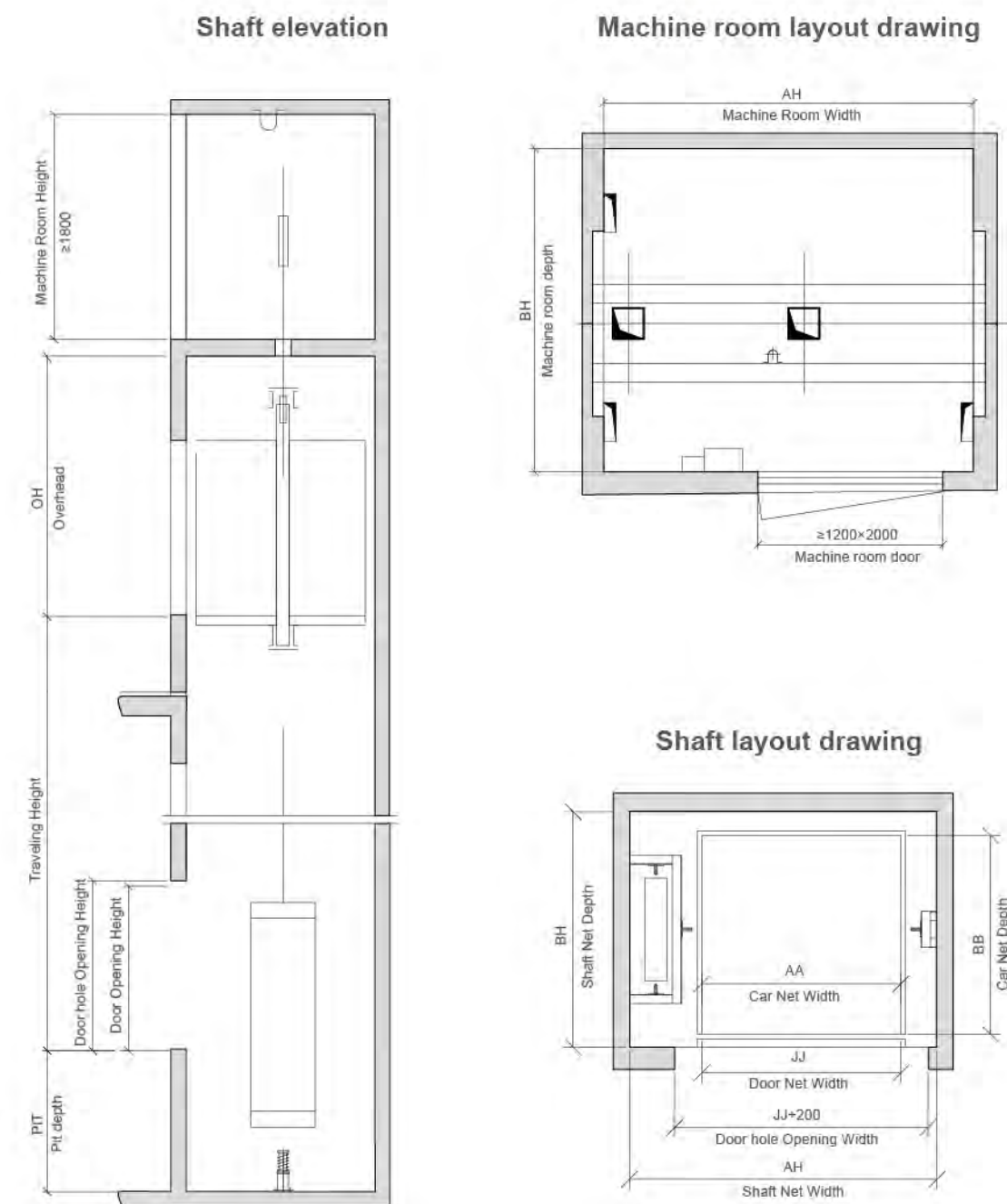

Dumbwaiter elevator specifications

Load kg	Speed m/s	Net door opening width x height (mm) Straight opening	Door open type	Car net size width x depth (mm)	Shaft Net Size (mm)		
					width x depth (mm)	PIT	OH
100	0.4	700×1000	Up/down straight opening	700×725	1250×925	1000	2500
200		950×1000	Up/down straight opening	950×975	1500×1175	1000	2500
250		1000×1200	Up/down straight opening	1000×1000	1550×1200	1000	2500
300	0.4/1.0						

Note: Only for reference, final manufacture please follow contract.

30° Escalator Construction Layout Drawing

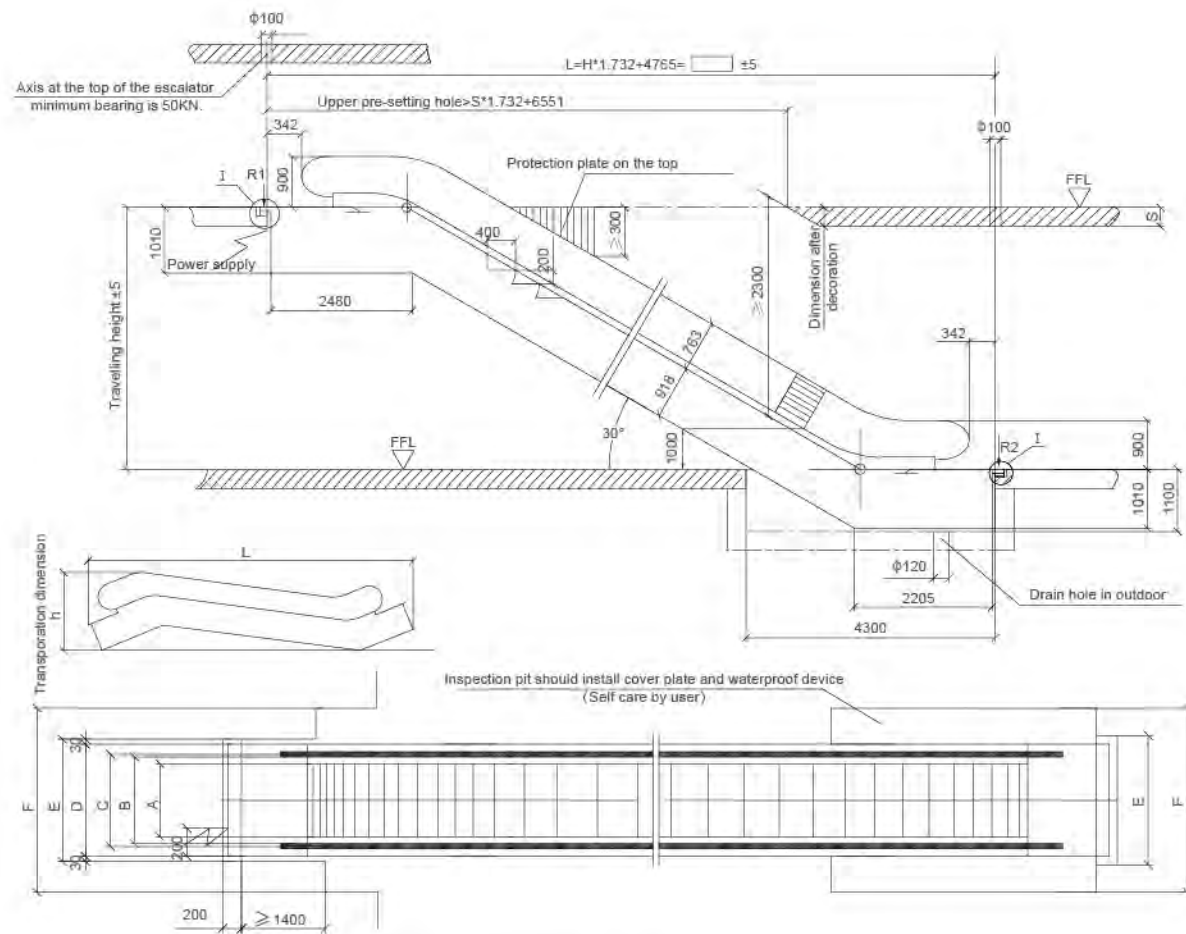

Motor capacity (KW)	Travelling height (Step width 1000)		Travelling height (Step width 800)		Travelling height (Step width 600)	
	Step width	KW	Step width	KW	Step width	KW
1000	1000	5.5	1000-3500	5.5	1000-3700	5.5
800	800	7.5	3600-4700	7.5	3800-4900	7.5
600	600	8	4800-5100	8	5000-5200	8
		11	5200-5900	11	5300-5900	11
Step width	A	B	C	D	E	F
Model	Travelling height (mm)		Net weight (KN)		Bearing capacity (KN)	
	h		R1 R2		Transporation dimension	
	h		h		h	
FML(600)-30 (3600Person/h) Speed: 0.5m/s	3000		57	46	41	2750
	3500		60	49	44	2780
	4000		64	52	47	2810
	4500		68	56	50	2830
	5000		71	59	53	2840
	5500		75	62	56	2860
FML(800)-30 (4800Person/h) Speed: 0.5m/s	3000		59	52	47	2750
	3500		63	56	50	2780
	4000		67	60	54	2810
	4500		71	64	57	2830
	5000		74	68	60	2840
	5500		82	74	66	2860
FML(1000)-30 (6000Person/h) Speed: 0.5m/s	3000		63	59	53	2750
	3500		67	64	57	2780
	4000		71	68	61	2810
	4500		75	73	65	2830
	5000		83	79	71	2840
	5500		87	84	75	2860

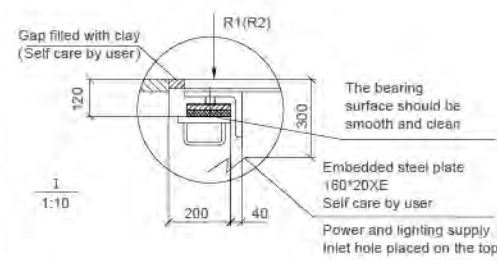

Instruction

- When the escalator is to be installed above the second floor, Don't have a pit. Layout drawing must be matched between up and down.
- Keep the sufficient space at both EXIT and ENTRANCE of escalator. The width must be less than 1238. The depth from handrail belt reversed end to the front obstacle must be not less than 2500.
- Space between handrail belt of escalator and obstacle must be not less than 500.
- Motor AC 380 V 50 HZ. See in the table.
- By the user to provide a grounding resistance of less than 4 ohms.
- Provide by user to the main switch of the power requirements of 3 phases 5 wires.
- All the dimensions are measured by MM.

35° Escalator Construction Layout Drawing

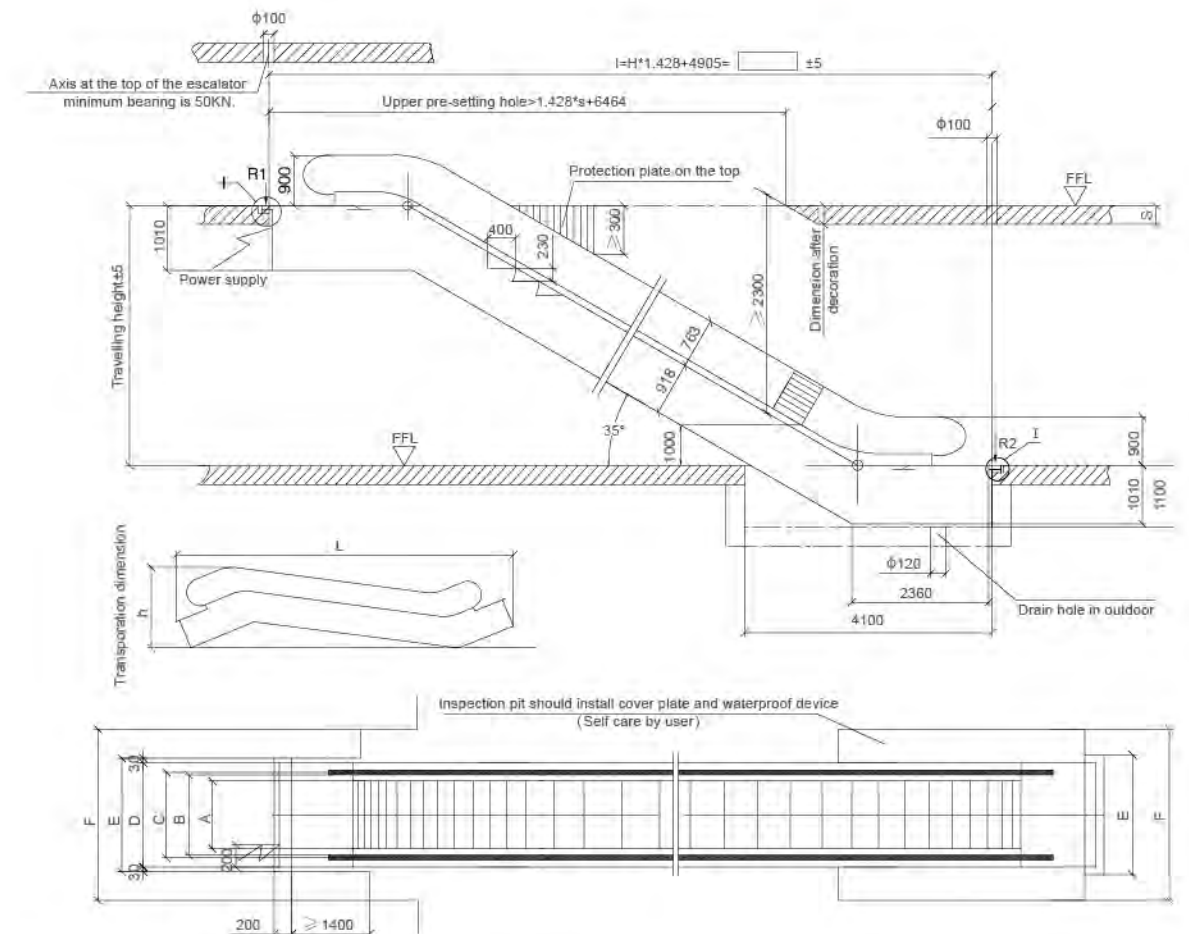

Motor capacity (KW)	Travelling height (Step width 1000)		Travelling height (Step width 800)		Travelling height (Step width 600)	
	Step width	KW	Step width	KW	Step width	KW
1000	1000	5.5	1000-3700	5.5	1000-3900	5.5
800	800	7.5	3800-4900	7.5	4000-5100	7.5
600	600	8	5000-5200	8	5200-5400	8
		11	5300-5900	11	5500-5900	11
Step width	A	B	C	D	E	F
Model	Travelling height (mm)		Net weight (KN)		Bearing capacity (KN)	
	h		R1 R2		Transporation dimension	
	h		h		h	
FML35/600 (3600Person/h) Speed: 0.5m/s	3000		54	43	39	2850
	3500		57	46	41	2890
	4000		60	52	47	2920
	4500		64	56	50	2940
	5000		67	59	53	2970
	5500		70	62	56	2980
FML35/800 (4800Person/h) Speed: 0.5m/s	3000		56	49	44	2850
	3500		60	52	47	2890
	4000		63	56	50	2920
	4500		66	59	53	2940
	5000		70	62	56	2970
	5500		73	65	59	2980
FML35/1000 (6000Person/h) Speed: 0.5m/s	3000		60	56	50	2850
	3500		64	60	53	2890
	4000		67	64	57	2920
	4500		71	67	60	2940
	5000		74	71	64	2970
	5500		82	77	69	2980

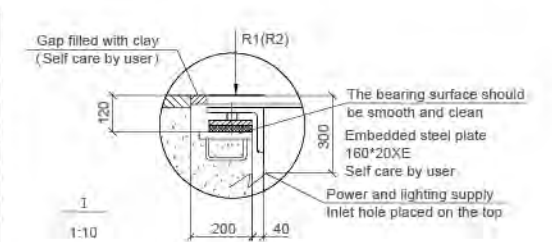

Instruction

- When the escalator is to be installed above the second floor, Don't have a pit. Layout drawing must be matched between up and down.
- Keep the sufficient space at both EXIT and ENTRANCE of escalator. The width must be less than 1238. The depth from handrail belt reversed end to the front obstacle must be not less than 2500.
- Space between handrail belt of escalator and obstacle must be not less than 500.
- Motor AC 380 V 50 HZ. See in the table.
- By the user to provide a grounding resistance of less than 4 ohms.
- Provide by user to the main switch of the power requirements of 3 phases 5 wires.
- All the dimensions are measured by MM.

Large Height Escalator Construction Layout Drawing

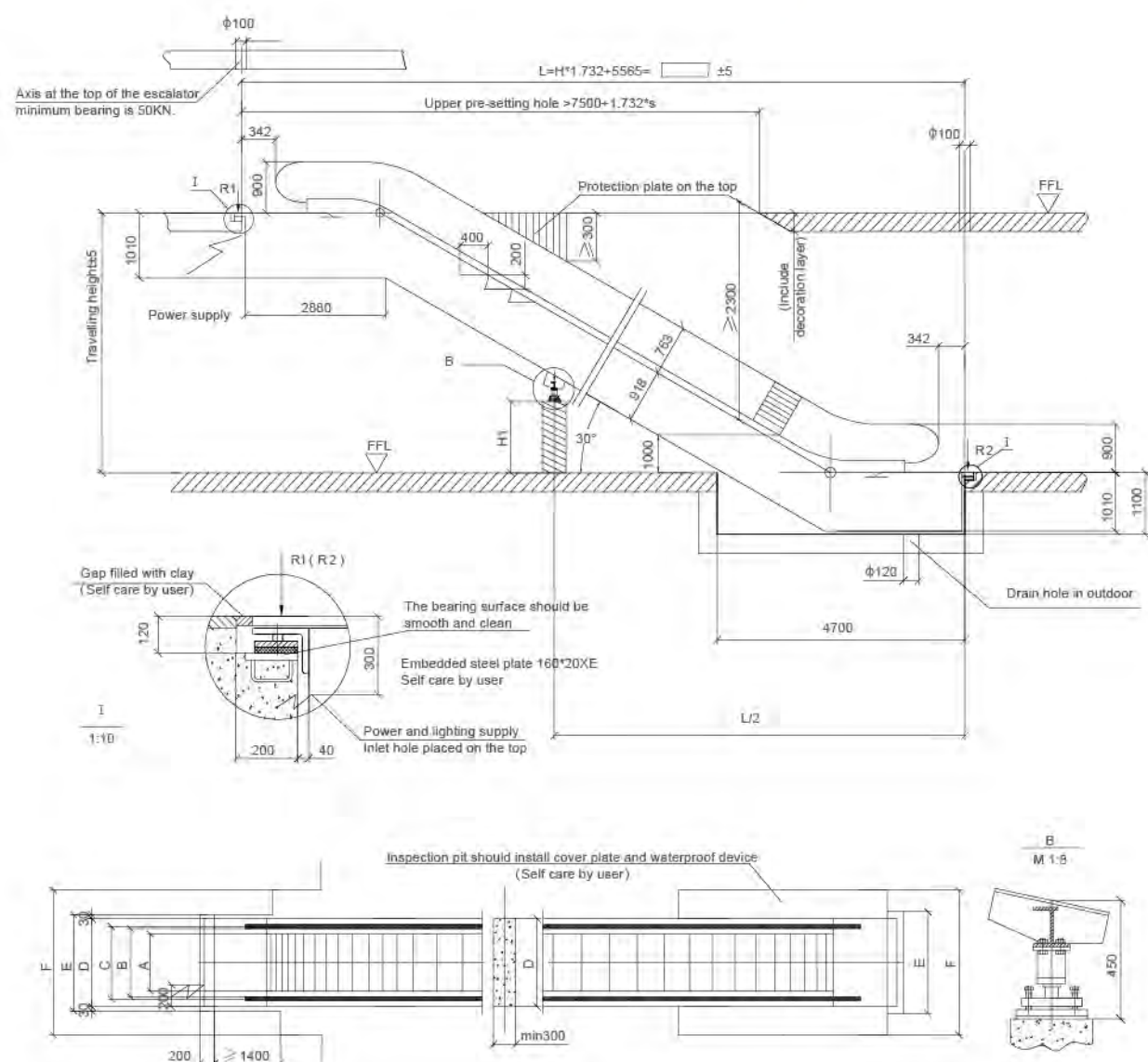

Motor capacity (KW)	Traveling height (Step width 1000)		Traveling height (Step width 800)		Traveling height (Step width 600)	
	6000-6600	11	6000-6800	11	6000-7000	11
1000	1000	1158	1238	1600	1660	2310
800	800	958	1038	1400	1460	2110
Step width	A	B	C	D	E	F

Note

1. When the travelling height of escalator is $6000 < H < 7800$, middle support should be set between the center of truss bearing beam. Height of middle support $H1 = H/2 - 1330$. 2. Bearing capacity of upper support beam $R1 = H^2 \cdot 0.007 + 46$. 3. Bearing capacity of downer support beam $R2 = H^2 \cdot 0.007 + 36$. 4. Capacity of center support $R3 = H^2 \cdot 0.0216 + 90$ User supply 380V AC 50Hz power. When moving walk start to work, the voltage reduced $\leq 10\%$ in normal situation, the voltage reduced $\leq 5\%$ when working. The mix started current should less 3.5 times than rated.

Instruction

- When the escalator to be installed above the second floor. Don't have a pit. Layout drawing must be matched between up and down.
- Keep the sufficient space at both EXIT and ENTRANCE of escalator. The width must be less than 1238. The depth from handrail belt reversed end to the front obstacle must be not less than 2500.
- Space between handrail belt of escalator and obstacle must be not less than 500.
- Motor AC 380 V 50 HZ. See in the table.
- By the user to provide a grounding resistance of less than 4 ohms.
- Provide by user to the main switch of the power requirements of 3 phases 5 wires.
- All the dimensions are measured by MM.

12° Moving Walk Construction Layout Drawing

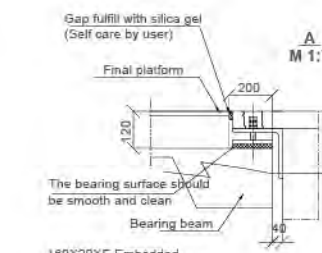
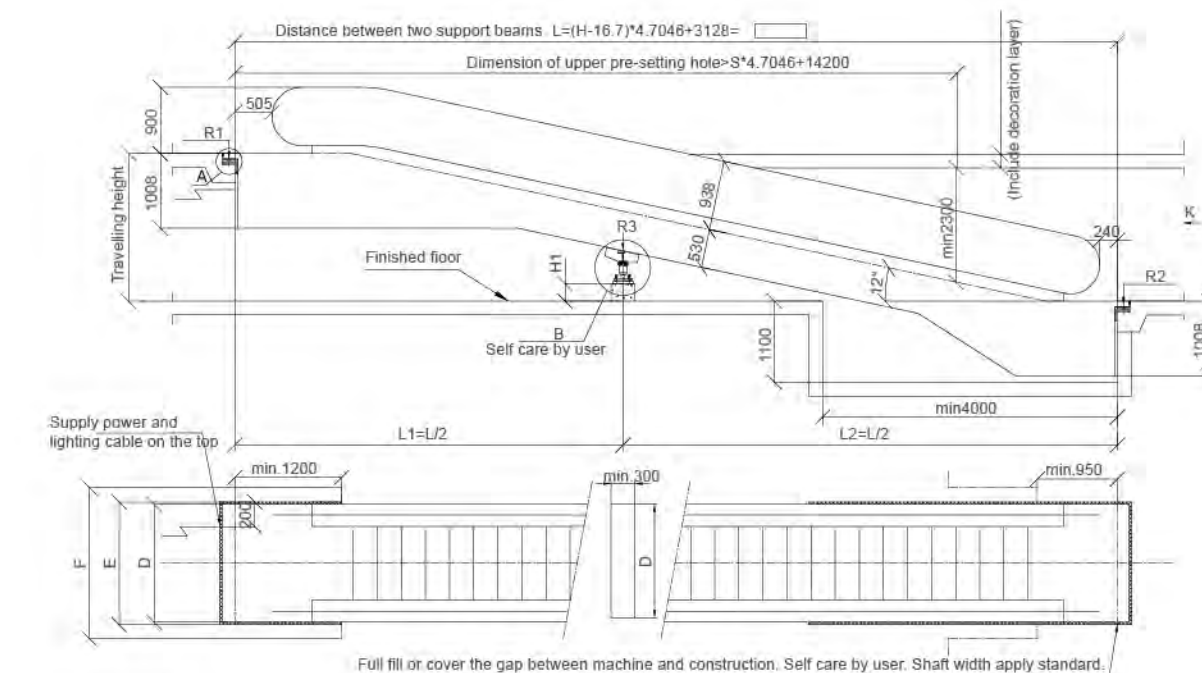

Motor capacity [KW]	Traveling height		Traveling height	
	1000-3000	5.5	1000-3200	5.5
	3000-4000	7.5	3300-4200	7.5
	4100-4200	8	4300-4400	8
	4300-6800	11	4500-7000	11
	6900-9000	15	7100-9200	15

Center supporting Height H1: When the traveling height $2600 < h < 5800$, we need to use one center support. And supporting height is $h1 = h/2 - 780$.

Center supporting height H1, Center supporting height H2: When the traveling height $5800 < h < 7800$, we need to use two center supports. The traveling height of first one is $h1 = h/3 - 881$, and second one is $h2 = 2h/3 - 681$.

Power supply: User needs to supply 380v ac 50hz three-phase five-wire power supply. Voltage should ≤ 10 when moving walk at the start and the voltage should be ≤ 5 in normal operation. Maximum starting current should less than 3.5 times of rated current.

Technical notes		
Dip angle α	12°	
Speed v	0.5m/s	
Step width A	1000	800
Handrail inner side distance B	1158	958
Handrail center distance C	1310	1110
Moving walk outside width D	1600	1400
Supporting beam length E	1660	1460
Exterior barrier width F	2310	2110
Pit width G	1660	1460
Support opposite force R1 [KN]	$0.009 \times L1 + 22$	$0.0078 \times L1 + 19$
Support opposite force R2 [KN]	$0.009 \times L2 + 10$	$0.0078 \times L2 + 9$
Support opposite force R3 [KN]	$0.0117 \times (L1 + L2)$	$0.01014 \times (L1 + L2)$
Support opposite force R4 [KN]	$0.0117 \times (L2 + L3)$	$0.01014 \times (L2 + L3)$

Notes

- When the moving walk is installed in the second floor and above, pit is canceled. And the bottom and top of construction should be symmetrical.
- Sufficient unblocked space is needed at entrance and exit of moving walk. The width should not less than 1310 and the depth from handrail belt swerving edge to any barrier should not less than 2500.
- The distance between moving walk and any barrier should ≥ 500 .
- User needs to supply a earth connection equipment with resistance less than 4 ohm.
- When the traveling height $H \leq 2600$, cancel to support R3, R4.
- When the traveling height $2600 < H \leq 5800$, we only need to support R3 and $L1 = L2 = L/2$.
- When the traveling height $5800 < H \leq 7800$, we only need to support R3, R4 and $L1 = L2 = L/3$.
- This plan is current 12° standard moving walk construction size. If the construction can not be executed, please contact Technology Department of FUJI Elevator Co., Ltd.
- The unit in this plan is millimeter. We reserve right to change without prior notice.

0° Moving Walk Construction Layout Drawing

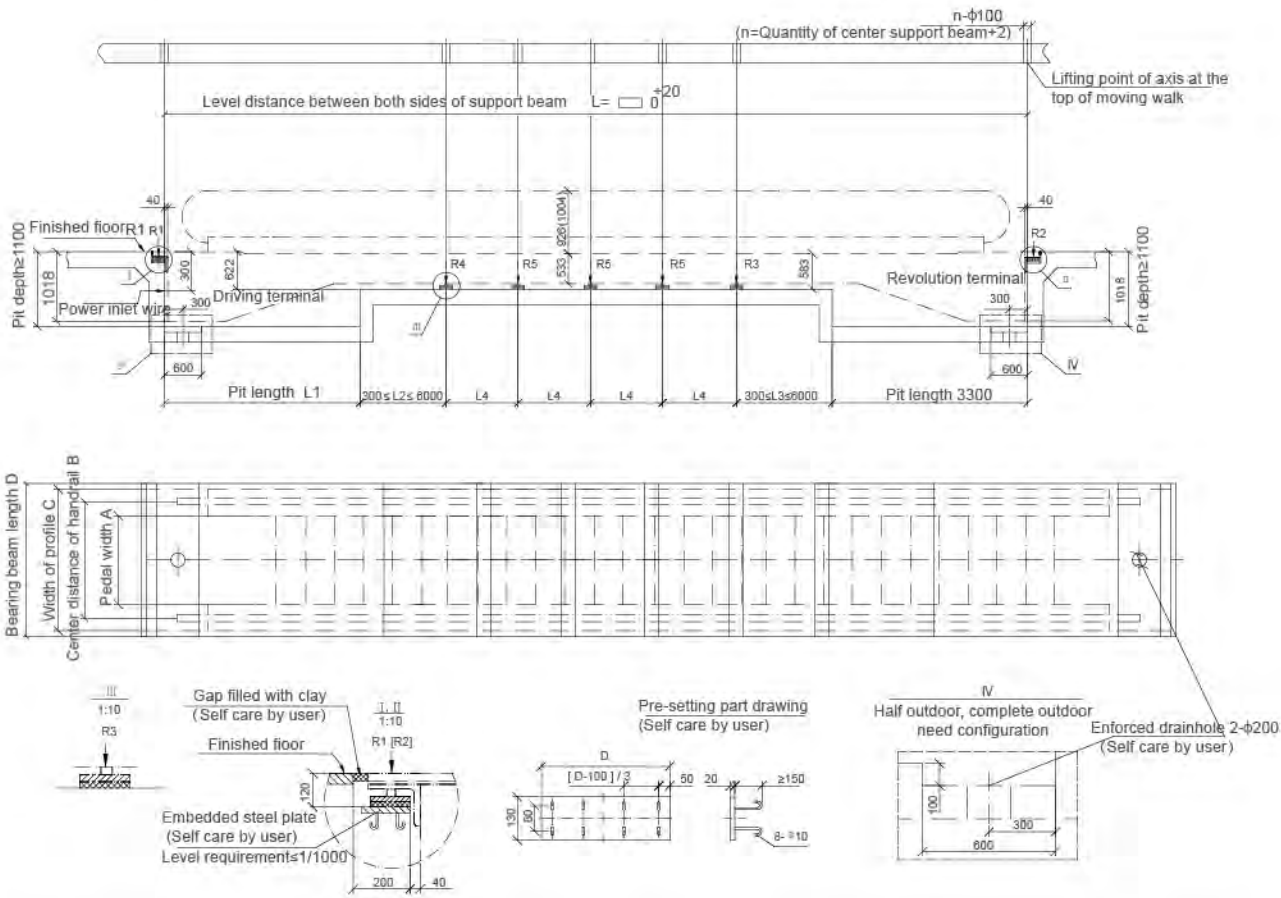

Pedal width	1000		800	
Quantity of center support beam L4	6000	10000	6000	10000
Support opposite force (KN)	R1	40	38	35
	R2	34.5	34	32
	R3	62.5	78.5	52
	R4	63.5	79.4	54
	R5	48	79.4	40
Motor capacity / Rated current	Conveyor length L		Conveyor length L	
	10000~70000	8KW/18A	10000~80000	8KW/18A
	70001~110000	11KW/25A	80001~110000	11KW/25A

Technical notes	
Dip angle	0-6°
Speed V	0.5m/s
Pedal type	Aluminium alloy (Indoor/Half outdoor/Complete outdoor)
Pedal width A	1000 800
Handrail center distance B	1238 1038
Moving walk outside width C	1600 1400
Machine supporting beam length D	≥1660 ≥1460
Installation place/drive mode	Length L1
Indoor/star delta	4000
Indoor/frequency	
Semi-outdoor/ star delta	
Semi-outdoor/ frequency	
Outdoor/ star delta	4600
Outdoor/ frequency	
Power supply	User needs to supply 380V AC 50Hz three-phase five-wire power supply. Voltage should ≤10 when moving walk at the start and the voltage should be ≤5 in normal operation. Maximum starting current should less than 3.5 times of rated current.

Notes

1. When the operating environment temperature under 0° (outdoor or semi-outdoor) need increase heater. 2. Sufficient unblocked space is needed at entrance and exit of moving walk and the width should be the center distance at least. The depth (from handrail turn end) should be 2.5m at least, this area width should more than two times of the handrail center distance, the depth can be reduced to 2m. 3. If have the pit should have waterproofing work(self-care by user). 4. The distance between moving walk and any barrier should ≥500, or the Triangle place of handrail and floor should install protecting board(self-care by user). 5. User provide power supply and earth connection equipment with resistance less than 4 ohm, it should leave two meters left margin line under the upper supporting beams. motor capacity according to left form. 6. Luminance at least should be 50Lx at entrance and exit of indoor moving walk, luminance at least should be 15Lx at entrance and exit of outdoor and semi outdoor (self-care by user). 7. If the middle supporting beam use steel frame structure, please ask FUJI Elevator Company for advice. 8. Two sides and bottom decoration of moving walk self-care by user.

Installation Notice

Besides Complying with the Drawing of the Contract, Attention Should Also be Drawn to the Following

To ensure the safety of the escalator and moving walk, free space should be large enough in the landing area. (See the minimum size right)

C= the distance of the handrails

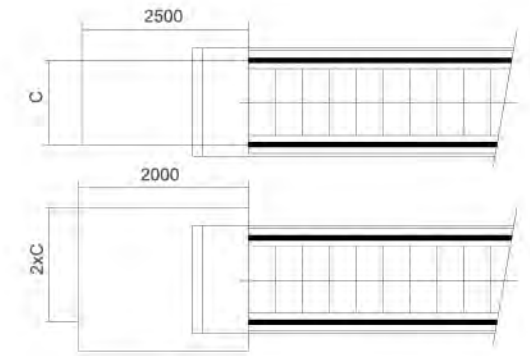

Note: The Graphical 1, 2, 3, 4 Safety Devices Function After the Escalator Installation and Before the Examination. They Are at the Users' Own Expense.

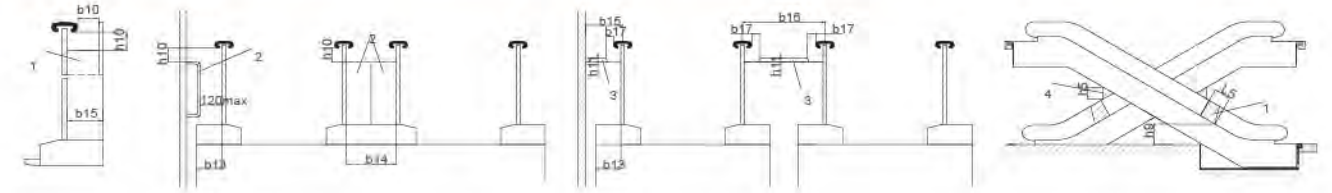

Description

- 1-Anti-creep device (5.5.2.2)
- 2-Blocking device (5.5.2.2)
- 3-Anti-skid device (5.5.2.2)
- 4-Vertical apron (A.2.4)

Vertical apron	Clauses	Vertical apron	Clauses
b13,b14,b15,b16	5.5.2.2	h10=25mm-150mm	5.5.2.2
b17≥100mm	5.5.2.2	h11≥20mm	5.5.2.2
h5≥0.30m	A.2.4	L5≥1000mm	5.5.2.2
h9=(1000±50)mm	5.5.2.2	b10=80mm	

Note: Graphical Representation is Not Proportional. It is Only Used for Graphic Illustration.

1. Outer cover plate of escalator / moving walk shall install anti-creep device (1). Please refer to above table for installing height of anti-creep device and extension length L5 of outer cover plate. Its height shall be the same as that of handrail surface. It shall also accord with the graphic stipulations.
2. When escalator / moving walk is adjacent to the wall, outer cover plate width b13 > 125mm, blocking device (2) shall be installed in upper / lower end. It prevents the people from entering into outer cover plate area. When escalator / moving walk is adjacent to paralleled layout, common outer cover plate width b14 > 125mm, the blocking device shall also be installed. It shall be extended to height h10.
3. When handrail cover-plate which is close to handrail height is installed between escalator / inclined moving walk and adjacent wall, and distance between building (wall) and handrail central line b15 is larger than 300mm, anti-skid device (3) shall be installed in handrail cover plate. Distance between anti-skid device and handrail shall ≥ b17. Spacing distance between anti-skid devices shall ≤ 1800mm. Height h11 shall ≥ 20mm. The device has no sharp angle / edge. As for adjacent escalator / inclined moving walk, when distance between handrail center-lines b15 > 400mm, anti-skid device shall be installed. It shall also satisfy above requirements.



Enjoyable Service

Full Service, Heart-to-heart Connection

Our service should not only ensure your security, but also guarantee your investment in the equipment aspects. The true service is to foresee and satisfy the special requirements from vast customers because the service's definition varies according to the customer's demands. Therefore we should have the extensive and characteristic methods to satisfy these requirements.

The Nation Wide After-sale Service Network

FUJI elevator sets up many branches in the main domestic cities. We provide the local customers with first time response at the first time and prompt replacement parts supply.

24-hour Emergency Repair Service

In order to urgently remove the problems, FUJI elevator specially sets 24-hour customer hotline. We will provide you with aid and service at first time.

